

# BRING ON THE POWER



# BLACK MAXX

## INSTALLATION MANUAL

FORD | GM | DODGE

# WARNING!

## THIS IS A HIGH PERFORMANCE PRODUCT TO BE USED AT YOUR OWN RISK!

Do not install this product until you have read and fully understand the following disclaimer of liability. The following disclaimer of liability sets forth the terms and conditions for the installation and/or use of this product. By installing this high performance product, the buyer acknowledges that they have read and fully understand this disclaimer and accepts its terms and conditions.

### DISCLAIMER OF LIABILITY

H&S Performance, LLC and their successors, distributors, jobbers, dealers, and retailers (SELLER) shall in no way be responsible for any direct, indirect, or consequential damage resulting from improper installation and/or use of this product. The BUYER/USER assumes all responsibility for any damage resulting from the use or misuse of this product **The buyer hereby waives all liability claims for the use of this product.**

The BUYER acknowledges that he/she is not relying on the SELLER's skill or judgment to select or furnish goods suitable for any particular purpose and that there are no liabilities which extend beyond the description herein, and the BUYER hereby waives all remedies or liabilities, expressed or implied, arising by law or otherwise, (including without any obligations of the SELLER with respect to fitness, merchantability and consequential damages) or whether or not occasioned by the SELLER's negligence.

The SELLER disclaims any warranty and expressly disclaims any liability for personal injury or damages. The BUYER acknowledges and agrees that the disclaimer of any liability for personal injury is a material term for this agreement and the BUYER agrees to indemnify the SELLER and to hold the SELLER harmless from any claim related to the product purchased. Under no circumstances will the SELLER be liable for any damages or expenses by reason of use or sale of any such products.

The SELLER assumes no liability regarding the improper installation, misuse, or misapplication of its products. It is the buyer and/or installer's responsibility to check for proper installation.

### LIMITATION OF WARRANTY

H&S Performance, LLC ("SELLER") gives Limited Warranty as to the description, quality, merchantability, fitness for any product's purpose, or any other matter of SELLER's product sold herewith. The SELLER shall be in no way responsible for the product's use and service and the BUYER hereby waives all rights other than those expressly written herein. This Warranty shall not be varied except by a written agreement signed and dated by SELLER and BUYER.

The Warranty is Limited to one (1) year from the date of sale and limited solely to the parts contained within the product's original packaging. All products that are in question of Warranty must be returned shipping prepaid to the SELLER and must be accompanied by a dated proof of purchase receipt. All Warranty claims are subject to approval by H&S Performance, LLC.

Under no circumstances shall the SELLER be liable for any labor charges incurred, or travel time incurred in diagnosis for defects, removal, or re-installation of this product, or any other contingent expenses. Any product deemed defective and consequently repaired or replaced by SELLER, shall retain the remainder of the warranty period from date of purchase, as the warranty period shall not be extended due to repair or replacement. Under no circumstances will the SELLER be liable for any damage or expenses incurred by reason of the use or sale of any such product.

If the buyer does not agree to the terms of this limited warranty or the disclaimer of liability, the buyer may return this product to the SELLER in a new and unused condition, along with dated proof of purchase, within 30 days of purchase, for a full refund. This warranty is null and void for any new products purchased through unauthorized dealers.

This warranty is null and void for any products sold as USED or REFURBISHED.

This warranty is null and void for any products purchased below the H&S UNILATERAL PRICING POLICY

## **EMISSIONS WARNING!**

This H&S product may be capable of disabling all or part of the emissions system on certain vehicle applications, when selected by the end user to do so. **EMISSIONS REMOVAL IS NOT LEGAL ANYWHERE WITHIN THE USA, UNLESS THE VEHICLE IS NOT REGISTERED WITH THE DIVISION OF MOTOR VEHICLES, AND IS BEING USED SOLELY AS A COMPETITION RACE VEHICLE. BY SELECTING ANY SETTINGS THAT CAN ALLOW REMOVAL OF EMISSIONS EQUIPEMNT, YOU ACCEPT ALL RISK AND LIABILITY ASSOCIATED WITH ITS USE, AND AGREE TO THE FOLLOWING TERMS AND CONDITIONS.**

1. All settings or calibrations that may allow emissions removal are intended and developed for off-highway, organized, sanctioned, closed-course RACE/COMPETITION USE ONLY! Any other use, on ANY road, public or private, within the USA, is STRICTLY PROHIBITED.
2. H & S Performance insists that you do not select any calibrations or settings if this vehicle has been registered or certified for highway use within the USA.
3. This product when used incorrectly may violate local, state, and federal laws pertaining to emissions, traffic, registration, and safety.
4. Use of this product may damage or destroy mechanical and/or electrical components of this vehicle.
5. Use of this product may void or nullify the vehicles factory warranty.
6. User understands that motorsports are dangerous, and that installation of this product may subsequently require special driving skills or techniques to safely operate the vehicle.
7. User assumes sole responsibility for the safe, proper, and legal use of the vehicle at all times.
8. The purchaser and end user releases, indemnifies, discharges, and holds harmless H&S Performance, LLC from any and all claims, damages, causes of action, injuries, or expenses resulting from or relating to the use or installation of this product that is in violation of the terms and conditions on this page, the product disclaimer, and/or the product installation instructions. H&S Performance will not be liable for any direct, indirect, consequential, exemplary, punitive, statutory, or incidental damages or fines cause by the use or installation of this product.

### **WARNING!**

Before allowing you to access any settings or calibrations that may allow emissions removal, you will be asked by the tuner to electronically agree to the terms and conditions listed above. By electronically agreeing to the terms and conditions, you are certifying that you are aware of and assume all risk, liability, and consequences that may arise from its use.

### **USE AT YOUR OWN RISK!**

### **INTERNET UPDATES:**

H&S Performance regularly issues free internet updates and custom tunes for the Black Maxx. Please check to see if there are any available for your truck by going to the downloads section at: [www.hsperformance.com](http://www.hsperformance.com)

### **TROUBLESHOOTING:**

Please read and understand all installation instructions before proceeding with the installation. If you have questions during the installation of this product, please call H&S Performance support at 1-888-628-1730

# TABLE OF CONTENTS

<b>BILL OF MATERIALS</b> .....	5
<b>PARTS DESCRIPTIONS</b> .....	6
<b>BLACK MAXX INSTALLATION</b> .....	9
Section 1: Mounting the Cradle.....	10
Dash Mounting .....	10
Windshield Mounting.....	12
Section 2: Installing the Pyrometer .....	13
Pre-Turbo/Post-Turbo Mount .....	14
Installing the PCH Board.....	15
Section 3: OBDII Adapter plug.....	16
Section 4: Installing the Power Wire .....	17
Section 5: How to dock the Black Maxx .....	18
<b>BLACK MAXX OPERATION</b> .....	19
Section 1: Button Navigation.....	19
Section 2: Install Download .....	20
Section 3: Exploring the Main Screen .....	21
Section 4: Exploring the Menu System .....	23
Section 5: Vehicle Setup.....	24
Defueling Parameters.....	24
Set Defuel Levels .....	25
Section 6: Other Black Maxx Features .....	26
Gauge Setup.....	26
Adjust Backlight .....	27
Change Background Color.....	28
Adjust Volume Setting .....	28
Diagnostics .....	29
Reset to Default Setting.....	30
Show Settings .....	31
T.V.# .....	31
SD Card .....	31
Web Updates .....	31
Section 7: Vehicle Specific Features.....	33
2003-2007 5.9L Dodge Cummins .....	33
2007.5-2009 6.7L Dodge Cummins.....	36
2010-2011 6.7L Dodge Cummins .....	40
2003-2007 6.0L Ford Powerstroke .....	45
2008-2010 6.4L Ford Powerstroke .....	47
2011-2012 6.7L Ford Powerstroke .....	50
2007.5-2010 6.6L LMM Duramax .....	54
2011-2012 6.6L LML Duramax.....	57
Section 8: Unplugging the Head Unit .....	62



## BILL OF MATERIALS

The list below includes by name the major parts included in your Black Maxx package. The tools list indicates all of the tools necessary to complete the Black Maxx install.

- |                           |                     |                   |
|---------------------------|---------------------|-------------------|
| 1. Black Maxx             | 5. OBDII Adapter    | 8. Dash Mount Kit |
| • SD Card (in Black Maxx) | 6. SD Card Reader   | • Base            |
| 2. Black Maxx Cradle      | 7. Pod Mount Kit    | • Top Arm         |
| 3. PCH Board**            | • Front Mount Plate | • Bottom Arm      |
| • Screws (2)**            | • Back Mount Plate  | • Top Plate       |
| • Zip Ties (4)**          | • Screws (4)        | • Bottom Plate    |
| • Velcro Strip**          |                     | • Screws (2)      |
| • Fuse Adapter**          |                     |                   |
| 4. Pyrometer Probe**      |                     |                   |

1.



2.



\*\*3.



\*\*4.



5.



6.



7.



8.

\*\* Optional

**PARTS DESCRIPTION**

*This section describes each of the parts in the Bill of Materials, the descriptions provide a physical set of attributes and a purpose for each part. The parts descriptions also list everything that is included in each assembly.*

**The Black Maxx Head Unit**

*The main component is the Black Maxx Head Unit. The Head Unit is the interface in which you control vehicle performance parameters. It is also the brains that will save vehicle activity and defuel a vehicle. Notice that the head unit has: seven total buttons, five on the left side and two on the right, a large color screen, an electronic plug for docking on the bottom and a snap hinge on the top also used for docking. Note that this is the last piece that you will install.*



**Note: Black Maxx includes an SD card inserted in the side of the Head Unit.**

**Black Maxx Cradle with Cradle Cable and Power Wire**

*The cradle itself is the docking station for the Black Maxx Head Unit. It acts as the means of communication for the Black Maxx. Notice that two wires come out of the bottom back side of the cradle, the Cradle Cable and the Power Wire. During the installation, the Cradle Cable runs to the OBDII Adapter Plug and the Power Wire runs to the vehicle fuse box.*

**OBDII Adapter Plug**

*The OBDII Adapter is rectangular and has a total of four electronic ports. The largest port on the top of the adapter plugs into the vehicle OBDII port. The three smaller ports on the sides include: a Cradle Cable port on one side, and on the opposite side a 4 Pin PCH Cable port and a 5 Pin Peripheral port. The main purpose of the OBDII Adapter Plug is to act as a hub for all communication lines between the Black Maxx and the vehicle.*



## Pyrometer Connection Head (PCH) Board Assembly\*

The PCH Board or Pyrometer Connection Head serves as a dock to connect the pyrometers into the Black Maxx system. The PCH Board includes the ability to connect two pyrometers. Attached to the PCH Board housing is a cable with four pin plug which connects to the OBDII Adapter Plug. The list below includes all separate parts that make up the entire PCH Board Assembly.

- PCH Board
- Velcro
- (2) Self-tapping Sheet Metal Screws
- Pyrometer Cable

\* Optional



## Dash/Windshield Mounting Assembly

This mounting assembly is recommended mainly for use on the dash of the vehicle, but can also be used in the same manner on the windshield of the vehicle. The assembly includes all parts and pieces necessary to mount the cradle, along with the Black Maxx to the vehicle dash or windshield. The list below includes all parts and pieces of this assembly (must be assembled by installer):

- Mounting Base
- Top Cradle Arm
- Bottom Cradle Arm
- Top Aluminum Plate
- Bottom Steel Plate (threaded)
- (2) Flat-head Screws



H&S Also offers custom vehicle specific solutions. See [www.hsperformance.com](http://www.hsperformance.com) for details.

### **Custom A-Pillar Mount Assembly**

*This mounting assembly enables the Black Maxx to be mounted on a custom pod. Using this mounting style does require that a Custom Pod be purchased from H&S Performance, but it also offers the cleanest install.*

*The Custom Mount Assembly includes:*

- *Front Mounting Plate*
- *Back Mounting Plate*
- *(4) Mounting Screws*



### **USB to SD Card Adapter**

*This Card Reader is used to update the Black Maxx's SD memory card . It is used primarily for internet updates.*





## INSTALLATION OVERVIEW

The installation overview illustrates a totally installed and functional Black Maxx system. This overview is meant to help reference the general location of installed parts and pieces of the Black Maxx. Notice that there are different overview diagrams. Use the correct diagram for your truck.

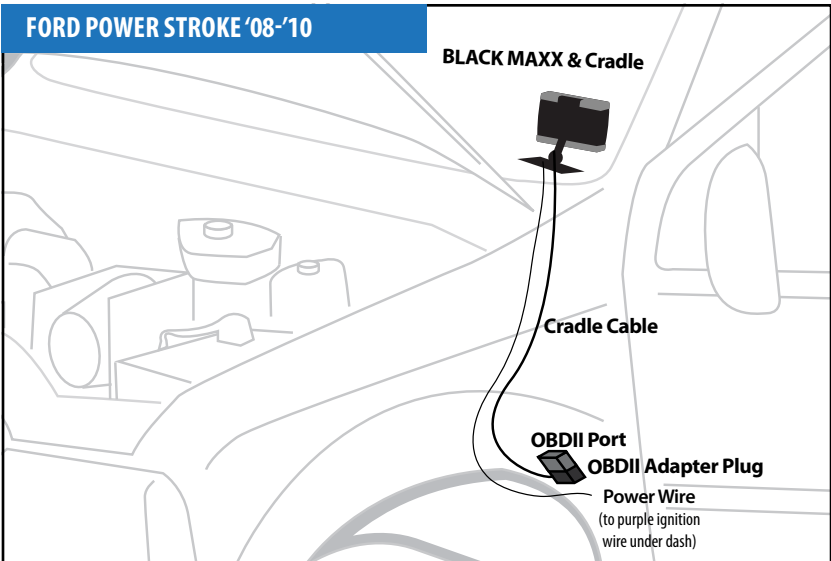
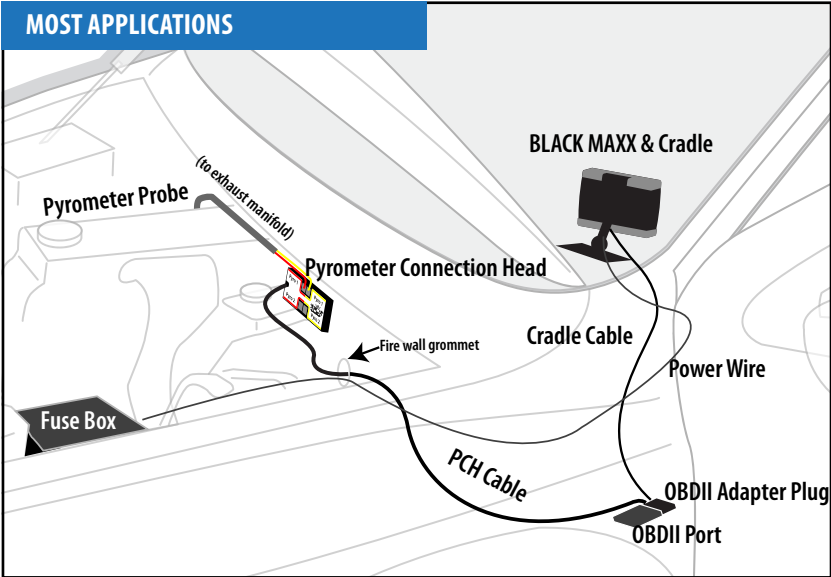

## BLACK MAXX INSTALLATION INSTRUCTIONS

### SECTION 1: MOUNTING THE CRADLE

*In this section you will decide where to mount the Black Maxx Cradle, so you are essentially choosing the location for the Black Maxx inside the vehicle cab. First, decide which mounting style you will choose for the Black Maxx; we offer three different styles of mounting:*

1. Custom Pod mounting (Refer to the instructions included with your custom pod)
2. Dash mounting
3. Windshield mounting

*The following mounting instructions outline how to mount the Black Maxx, explaining each mounting style individually.*

### DASH MOUNTING

*Dash mounting is a quick and easy way to mount the Black Maxx. The dash mounting pieces do require some assembly. Dash mounting requires all parts in the dash mount assembly diagram (pg. 15).*

#### TO ASSEMBLE:

1. Gather the Dash Mounting assembly pieces:
  - Top Mounting Arm
  - Bottom Mounting Arm
  - The Cradle with Cradle Cable
  - Dash Mounting Base with Foam Tape
  - Top Plate
  - Bottom plate (with threads)
  - (2) Flat-Head Screws
2. Insert the metal top plate into the recessed area on top of the top mounting arm and hold it in place while inserting the bottom plate into the bottom mounting arm (note: the bottom plate has threaded screw holes).
3. Bring the arms together with the ends of the arms covering the ball on the cradle back and the ball on the mounting base. When together they will form two ball joints connected by a single arm.
4. Insert the two Flat-Head screws in the two holes in the top plate and then thread them into the bottom plate through both arm pieces. Hand tighten the screws just enough so that the assembly stays in one piece. You will fully tighten the screws once a mounting location on the dash has been located and a desired angle for mounting is chosen.

## DASH MOUNTING DIAGRAM

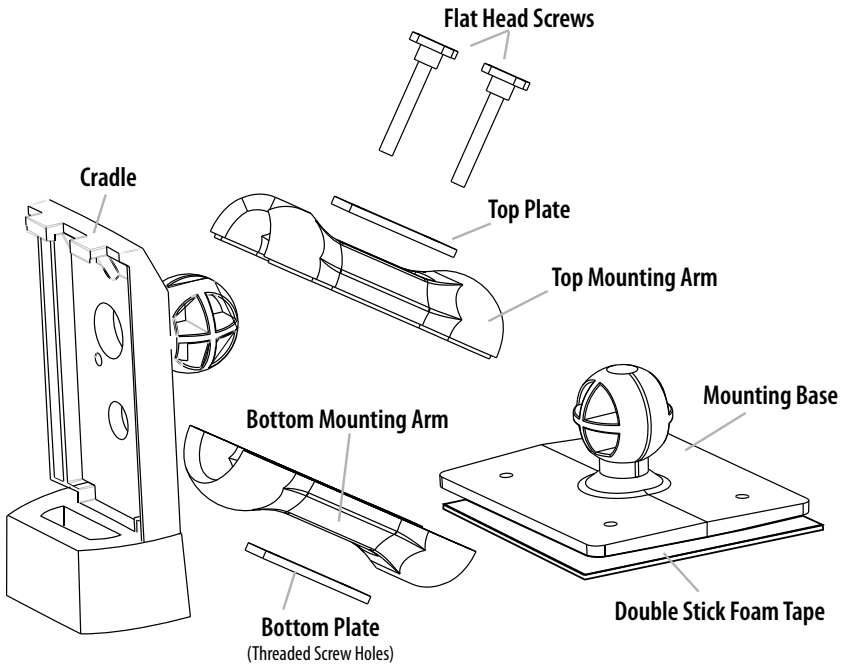

## **DASH MOUNTING CONTINUED**

5. Once a mounting location is chosen, determine the position of the Black Maxx and direction the Black Maxx will face by moving the ball and socket joints of the dash mount assembly. Once you find the right position tighten down the two Flat-Head screws to secure that position, the screws must be tightened sufficiently to hold the Black Maxx in position.
6. Make sure that the mounting location on the dash is cleaned, preferably with isopropyl alcohol. Peel the backing off of the double stick foam tape on the bottom of the dash mounting base and stick the dash mount assembly along with the cradle to the dash. Press down firmly to ensure that the adhesive reaches full contact with the dash.
7. Run the end of the Cradle Cable down through the driver's side of the vehicle dash and pull all of the extra slack in the cable down also. The Cradle Cable Plug will need to be connected to the OBDII Adapter Plug and the Power Wire will need to be hooked to a fuse in the vehicle fuse box.

## **DASH MOUNTING DIAGRAM**

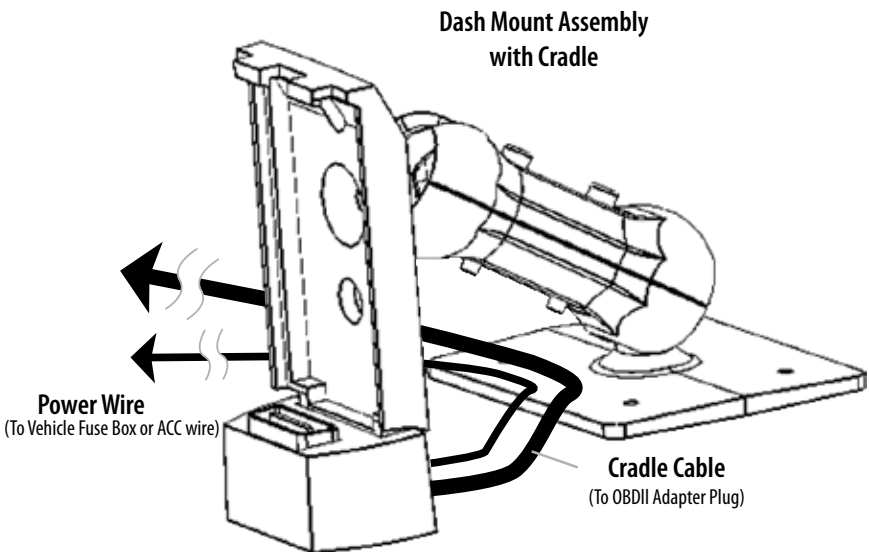

## **WINDSHIELD MOUNTING**

*Follow the same instructions for the dash mount procedure; apply the same instructions to the windshield of the vehicle rather than the dash.*

## SECTION 2: INSTALLING THE OPTIONAL PYROMETER AND THE PYROMETER CONNECTION HEAD (PCH)

**\* The Pyrometer and PCH are optional and some vehicles will not require them. Your vehicle may have a factory solution for reading Exhaust Gas Temperatures.**

*In this section you will drill and tap the Pyrometer Probe in the exhaust, either pre-turbo or post-turbo as a means to collect exhaust gas temperatures (EGT). Exhaust gas temperatures indicate how hot the motor is getting and can be used to set safety defueling parameters.*

### POST-TURBO VS. PRE-TURBO

You must decide between mounting the Pyro Probe either post-turbo or pre-turbo. The difference in location determines what temperatures will read on your Black Maxx. Pre-turbo mounting is generally recommended because it provides more accurate EGT readings.

The Black Maxx is capable of running two pyrometers simultaneously. Please purchase an extra probe, if you wish to read pre AND post turbo pyrometers.



## PRE-TURBO MOUNT

1. Drill a  $\frac{5}{16}$ " hole into the exhaust manifold where all the exhaust runners of the manifold come together, just before the turbo exhaust inlet. Then tap the hole with a  $\frac{1}{8}$ " NPT tap and mount the Pyrometer Probe in the hole. Use a  $\frac{9}{16}$ " wrench to tighten the probe holder or tube fitting to the down tube. Then tighten the Pyro Probe Cap to the holder using a  $\frac{9}{16}$ " wrench.
2. Run the Pyro Cable up to engine bay; let the end of the cable sit while installing the PCH Board.

For pictures and vehicle specific information, see the Vehicle Specific Features/Info Section starting on Page 33.

**WARNING:** If any debris such as drill bits and metal shavings drop inside the manifold, we advise that the manifold be removed from the vehicle so that the debris can be removed before starting the vehicle again.

### TOOL TIP, PRE-TURBO MOUNT

When drilling into the exhaust manifold, metal spews, shavings, and broken drill bits can fall inside. This can be hazardous to your turbo when the engine starts. Try doing four things to avoid this possible problem. One, use a high quality twist bit and a slow speed drill, about 500-800 rpm. Two, start with a small pilot bit about  $\frac{1}{8}$ ", then use the full  $\frac{5}{16}$ " bit after the smaller one has punched through. Three, grease your drill bit in addition to the normal lubricant, this will catch flying spews as they are cut. Four, just prior to punching through into the inside of the manifold, start the engine and build up exhaust pressure on the inside of the manifold (blows spews outside the manifold instead of letting them fall inside).

## POST-TURBO MOUNT

1. Find a location on the exhaust pipe that is 3-6" downstream from the turbo charger output. Then drill a  $\frac{5}{16}$ " hole and run a  $\frac{1}{8}$ " NPT tap into the hole. Mount the Pyrometer Probe in the threaded hole using a  $\frac{9}{16}$ " wrench to tighten the probe holder or tube fitting to the down tube. Then tighten the Pyro Probe Cap to the holder using a  $\frac{9}{16}$ " wrench.
2. Run the Pyro Cable along the brim of the engine bay, and then let the end sit when installing the PCH Board.

For pictures and vehicle specific information, see the Vehicle Specific Features/Info Section starting on Page 33.

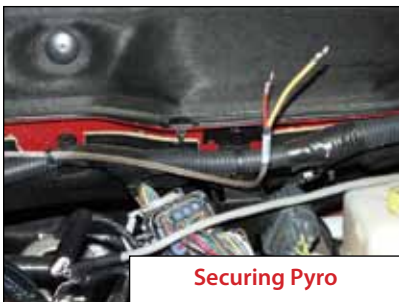

## INSTALLING THE PCH BOARD

*The pyrometer that was installed will now have to be connected to the PCH Board, but first the PCH Board needs to be mounted in a secure location that both of the pyrometer ends can reach.*

1. Gather all of the parts of the PCH Board assembly:

- Pyrometer Connection Head with PCH Cable
- Self-tapping Sheet Metal Screws
- Velcro
- Jumper
- Zip Ties

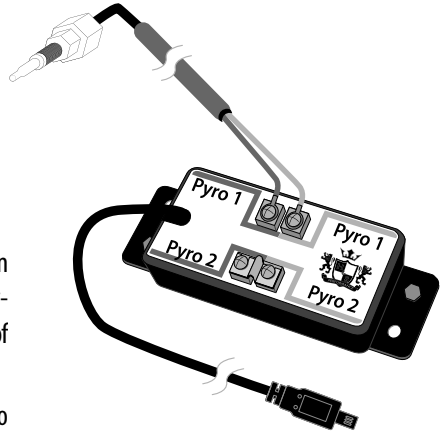

2. The PCH Board needs to be mounted in a location that is secure (away from extreme heat and moving parts), and in a location in which the end of the Pyrometer Cable can easily reach.

3. Use the sheet metal screws or Velcro, or both to securely attach the PCH Board to a safe location within the engine bay.

4. To connect the end of the Pyrometer Cable to the PCH Board, first remove the screw and nut on the end of the pyrometer leads, then remove the screws from the Pyro 1 heads on the PCH Board. Use those screws to secure the Pyrometer Cable leads to the PCH Pyro 1 heads, see the PCH Assembly Diagram (pg. 19) for a visual reference when connecting the pyrometer leads to the PCH Board.

**Notice: Do not remove the jumper from the Pyrometer 2 location unless you are installing a second pyrometer.**

**If connecting two pyrometers keep track of which location, Pyro 1 or 2, each pyrometer was attached to on the PCH Board**

5. Once the PCH Board is secure and the pyrometer is connected to the PCH Board, use zip ties to secure the pyrometer cables away from extreme heat and moving parts.

6. Run the end of the PCH Cable through the fire wall. It will need to be connected to the OBDII Adapter Plug. Use zip ties to secure all remaining cable left inside the engine bay.

### SECTION 3: OBDII ADAPTER PLUG

In this step you will connect the Cradle Cable and the PCH Cable to the OBDII Adapter Plug and then plug the OBDII Adapter plug into the to the Vehicle OBDII port.

1. Locate the OBDII Adapter Plug.
2. Plug the Cradle Cable and the PCH Cable into the OBDII Adapter Plug. See the OBDII Adapter Plug Diagram for a visual description.
3. Locate the OBDII port on the vehicle; OBDII ports are located under the dash on the driver's side. These ports are located in different areas under the dash for different vehicle applications; see the OBDII port locations diagram.
4. Plug the OBDII Adapter Plug into the OBDII port; see the Installed OBDII Adapter Plug diagram for an example of the finished install.

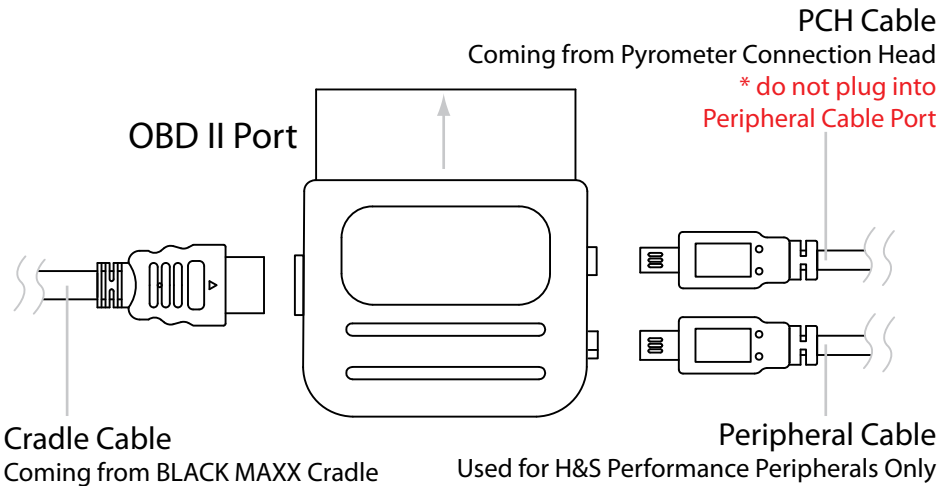
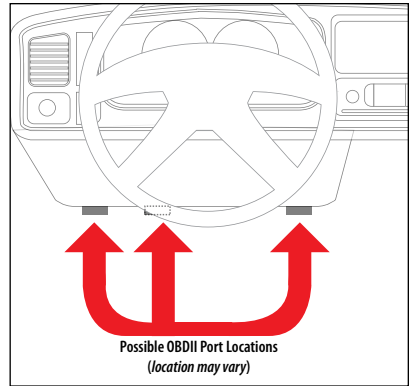

**Note:** On some vehicles it is recommended to move the OBDII port to a safer location. Because the Black Maxx will remain plugged in, the adapter can be kicked/bumped and broken. Please move your OBDII connection to a safer location if you feel it is in a position that may allow it to get damaged.

## SECTION 4: INSTALLING THE POWER WIRE

*In this section you will run the Power Wire coming from the Black Maxx Cradle to the vehicle fuse box and connect it to the fuse locations specified below. The fuse location for the Power Wire is different on each vehicle application.*

### CONNECTING THE POWER WIRE:

1. Route wire to location shown in pictures found in the [Vehicle Specific Section on page 33](#)
2. Remove the fuse, indicated in the pictures, and insert the fuse jack. Make sure that the fuse jack is placed on the dead side of the fuse to ensure that the Black Maxx is protected by the fuse. Use a volt meter to verify the dead side of the fuse. With the fuse pulled and the truck powered on but not started, the volt meter should read 0 volts on the fuse jack to ground. Problems that can occur if the incorrect fuse is used for this connection: the power may stay on continuously even with the key off; or, the Black Maxx can receive power at the incorrect time of the power-on/starting cycle of the vehicle.
3. Run the power wire through the fire wall before preparing the Power Wire. Prepare the Power Wire by stripping the end of the wire about ¼". Connect the blue 90° connector to the end of the Power Wire using crimping pliers.
4. Connect the Power Wire to the fuse jack, place the fuse back into the slot, and close the fuse box.

## SECTION 5: HOW TO DOCK THE BLACK MAXX

The Black Maxx and cradle can be damaged if the Black Maxx is not carefully placed onto the cradle. See the diagrams below for proper installation. Note that the diagrams show the Black Maxx being docked on to the dash/windshield mounting styles, but the Black Maxx docking instructions are the same for the A-Pillar mount as well.

### 1. The Key Must Be Off!

Make sure that the docking port on the bottom part of the cradle is flipped forward as far as it will go.

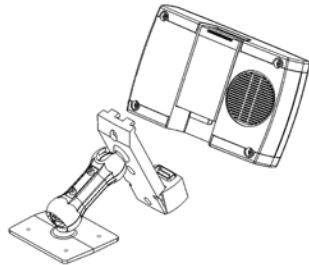

2. Dock the Black Maxx onto the cradle.

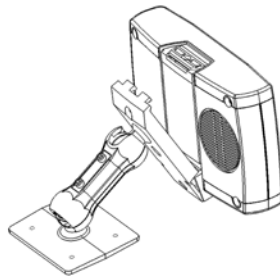

3. Once docked, rotate the Black Maxx back and snap it into the cradle.

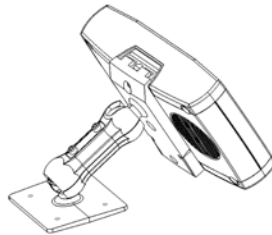

Note: Check the cradle swivel to make sure that it is connecting up to the Black Maxx correctly. The bottom of the swivel should be flush with the bottom of the Black Maxx.

### Removing the Black Maxx:

1. When removing the Black Maxx, simply press down on the top part of the Black Maxx that snaps into the top of the cradle.
2. Rotate the Black Maxx forward on the docking port.
3. Pull the Black Maxx up and out of the cradle.

### Almost Done!

You need to install the download now. Read the next section for Install Download procedure.



## BLACK MAXX OPERATING INSTRUCTIONS

These operating instructions are split into sections:

- **SECTION 1:** Button Navigation
- **SECTION 2:** Install Download
- **SECTION 3:** Exploring the Main Screen
- **SECTION 4:** Exploring the Menu System
- **SECTION 5:** Vehicle Setup
- **SECTION 6:** Other Black Maxx Features
- **SECTION 7:** Vehicle Specific Features
- **SECTION 8:** Unplugging the Head Unit

### SECTION 1: BUTTON NAVIGATION

Press the top left button to enter the Main Menu, also use this button to exit menus.

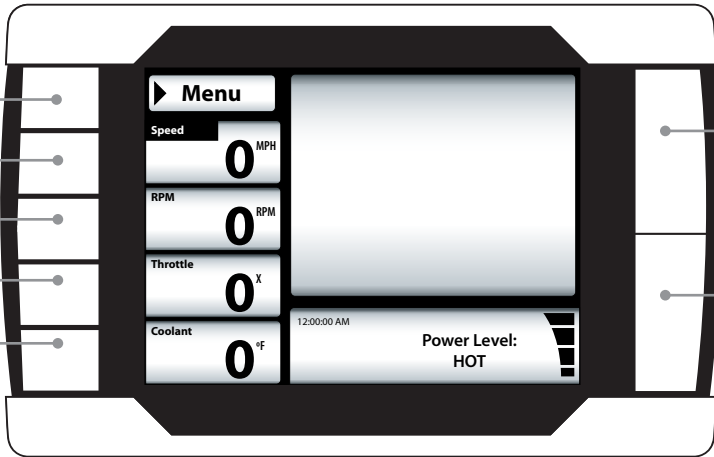

Press any of the four buttons on the left to select items on the screen that coincide with the button position.

In general these buttons work as up and down buttons, they may also be used to select items on the screen which coincide with the buttons.

## SECTION 2: INSTALL DOWNLOAD

*The Install Download option is used to install tuning onto a vehicle, or return a vehicle to stock.*

1. **Press Menu:** To get into the Black Maxx main menu.
2. **Select Install Download:** You may have to “Arrow Down” or “Arrow Up” to find this option.
3. **Install a download onto a stock vehicle:** If the vehicle is stock and you enter the install download menu, simply follow the screen prompts to install a download on the vehicle. This is the point in which you may come across the DPF selection menu, tire size calibration menu, and the vehicle speed limiter menu.

**Change Download Settings:** If the vehicle already has a download on it from the Black Maxx that is currently installed on that vehicle. This option is used to install updated or custom tuning. Updated and Custom tuning can be download for the H&S Performance website.

**Return a vehicle to stock:** To completely return a vehicle to its factory stock conditions you need to select this option. This is highly recommended when taking the vehicle in for any kind of service.

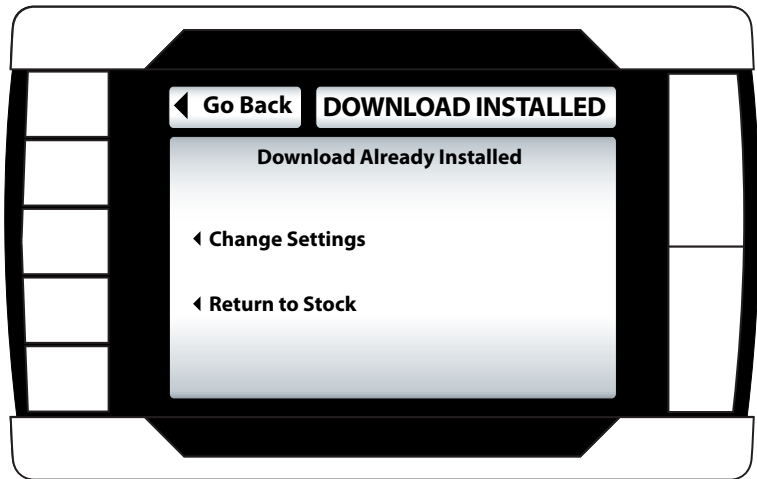

This Black Maxx screen shot shows what you will see if a download has already been entered into a vehicle.

Before installing the download:

- Make sure that the Black Maxx is properly docked in the cradle.
- Make sure that the harness is properly installed.
- The vehicle battery is fully charged.
- The vehicle is warmed up to operating temperature.

**THE SD CARD MUST BE INSERTED IN THE SIDE OF THE BLACK MAXX TO DOWNLOAD TO A VEHICLE.**

### SECTION 3: EXPLORING THE MAIN SCREEN

The Main Screen is where you view all of the vehicle activity. In this section you will learn how to navigate the Main Screen and learn about all of the different parts of the Main Screen.

#### MAIN SCREEN NAVIGATION

Below are descriptions of how all of the Black Maxx buttons work and what they do while in the Main Screen. The buttons perform different functions while in a menu or submenu.

Press the top left button to enter the Main Menu, also use this button to exit menus.

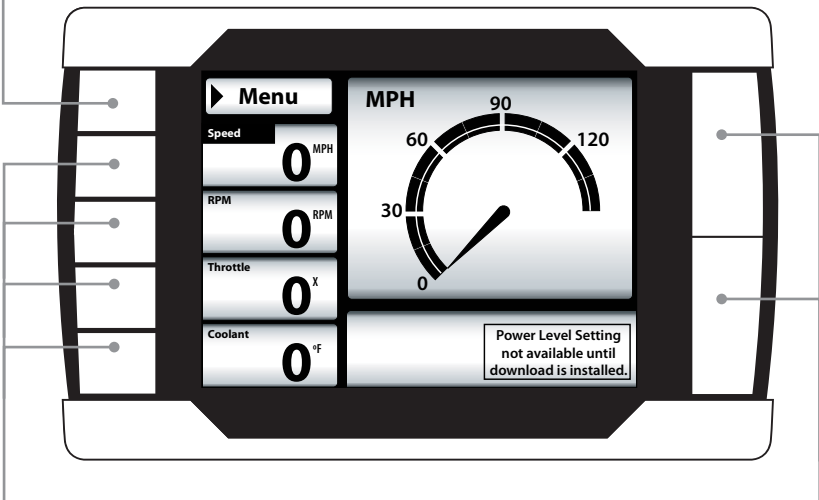

Press any of the four buttons on the left that coincide with the four vehicle parameters to display that particular vehicle parameter on the large gauge in the upper right side of the screen. Hold a button down to view the different graph types for the large gauge.

Power Level Up  
Power Level Down  
Use the power level buttons to control power levels on-the-fly only while in the main screen

## MAIN SCREEN PARTS DESCRIPTION

This section will describe all of the different parts of the Main Screen.

The black bar: The black bar highlights the title of one of the four displayed vehicle parameters to indicate that vehicle parameter is also being displayed on the large gauge.

Menu button: press to enter the main menu.

Large Gauge

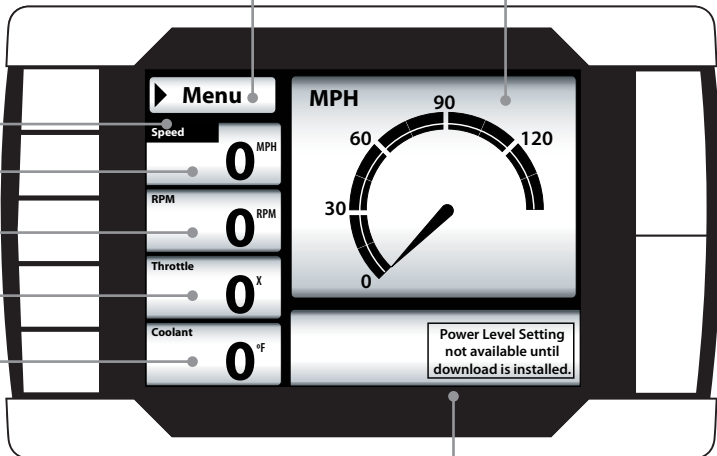

Vehicle parameters: To change which vehicle parameter is displayed in the large gauge area simply press one of the four buttons next the preferred vehicle parameter.

By pressing and holding the button next to your displayed gauge, you can change the display style in the large gauge area.

Power level text: Displays which power level is active, whether it be: Stock, Mild, Wild, or Hot.

Note: This will not be active if the Download has not been installed.

## SECTION 4: EXPLORING THE MENU SYSTEM

The diagram below shows all of the Main Menu items and explains the Main Menu navigation.

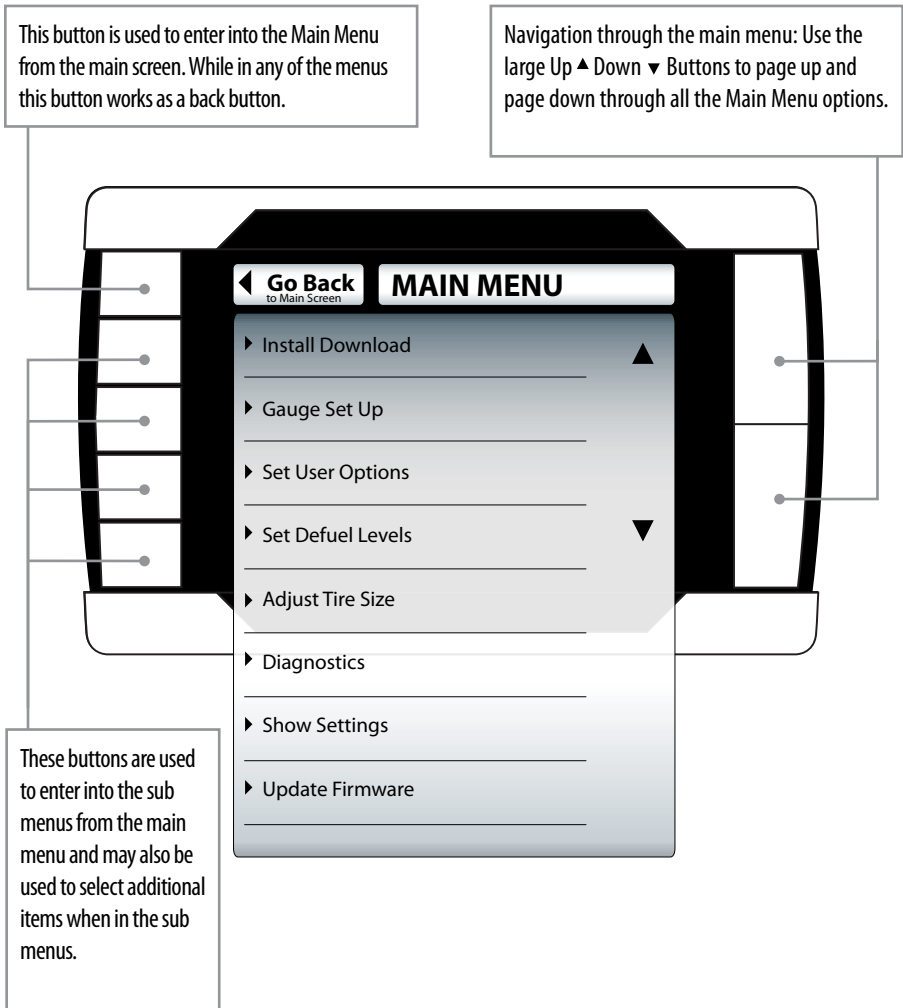

## SECTION 5: VEHICLE SETUP

This section describes various non-vehicle specific features of the Black Maxx

### DEFUELING PARAMETERS

Set up defueling parameters based on a number of different vehicle parameters. In this menu you can also turn vehicle parameters off. The defueling parameters available are vehicle specific, so not all defueling parameters are available for every make and model.

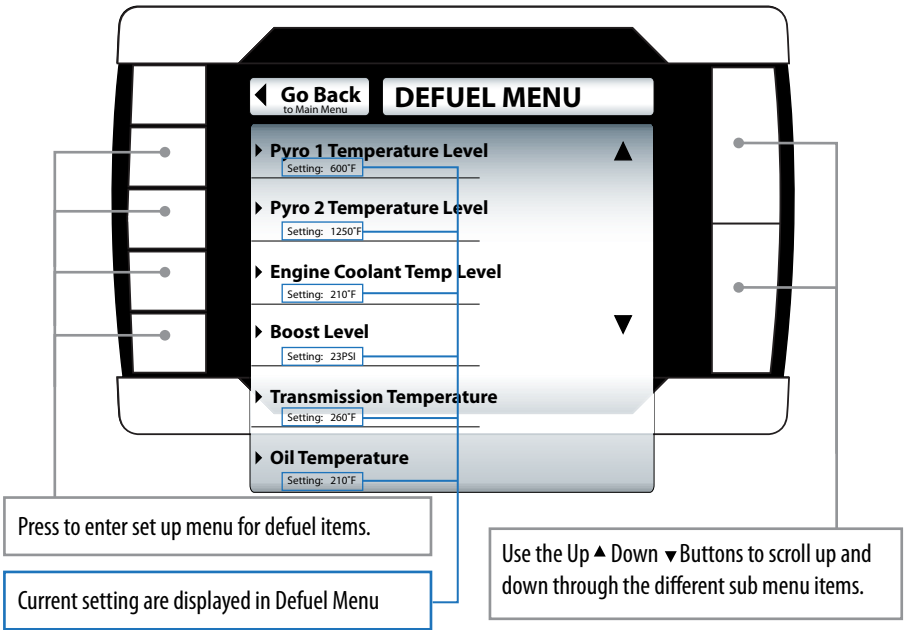

#### Default Defueling Settings

Pyro 1 Temperature Level	1450°F
Pyro 2 Temperature Level	OFF
Engine Coolant Temp Hot	210°F
Engine Coolant Temp Cold (cold start protection)	OFF
Boost Level	OFF
Transmission Temp Level	OFF
Oil Temperature	OFF

Here is a list of all of the defueling capabilities for the Black Maxx. All defueling options can be activated at the same time, all can be turned off, or a mix of on and off. Each defueling option is adjusted individually to be on or off and set to a particular defueling temperature.

## SET DEFUEL LEVELS

When entering a setup menu for any of the defuel options the menu will have a list of defuel levels to select from based on that specific defuel parameter. The selected value is displayed on the left, to select a defuel level you need only highlight the amount and then exit the setup menu. To turn any particular defuel parameter off press the bottom left button.

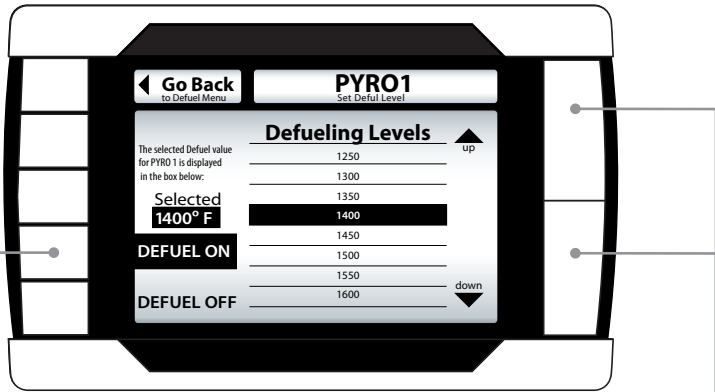

Use this button to turn the defueling on.

Use the large Up ▲ Down ▼ Buttons to scroll up and down through the different sub menu items.

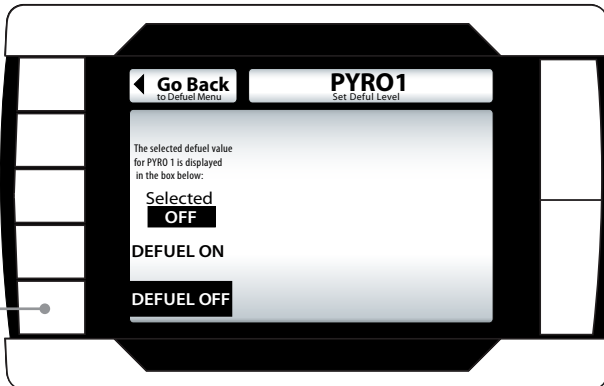

Use this button to turn the defueling off.

## SECTION 6: OTHER BLACK MAXX FEATURES

*This section describes all the customizing features of the Black Maxx.*

### GAUGE SETUP

Enter to change the vehicle parameters displayed on the four gauge locations in the Main Screen. This is also where you can see all of the most up-to-date vehicle parameters available to your vehicle make and model after running an internet upgrade.

Selecting a vehicle parameter to display in a particular location is done by highlighting the gauge location and then highlighting the desired vehicle parameter.

Once the correct vehicle parameter for a gauge location has been highlighted, you do not need to press another button to select that vehicle parameter. Simply highlighting the vehicle parameter makes it active in that location.

Notice that upon entering the gauge setup menu that, Set Gauge 1, is highlighted in black. When a gauge location is selected it is highlighted in black on the left and it also appears above the vehicle parameter selection box.

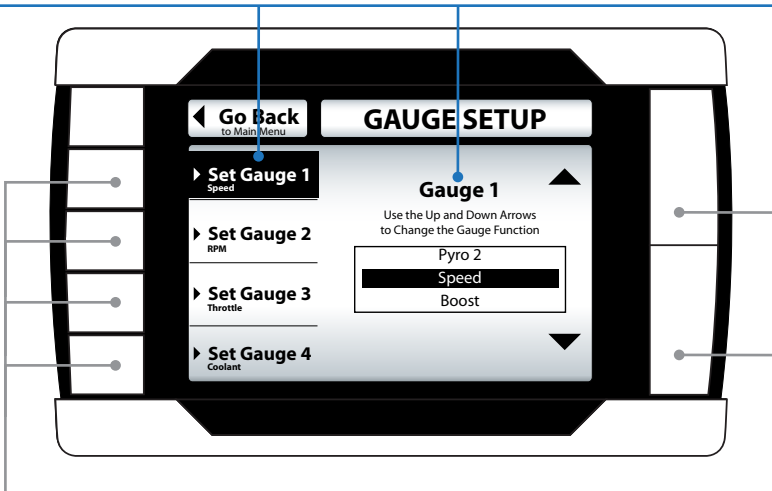

To highlight a different gauge location press the selection button that coincides with that gauge location. So to select gauge location 1, press the second button down on the left hand side of the Black Maxx. To select the 4th gauge location press the bottom button or the 5th button down on the left side.

Use the large Up ▲ Down ▼ Buttons to highlight a particular vehicle parameter for any of the gauge locations.

## ADJUST BACKLIGHT

Highlight either keypad or screen and use the up and down buttons to adjust the lighting to your preference.

Use this button to select the Key Pads option.

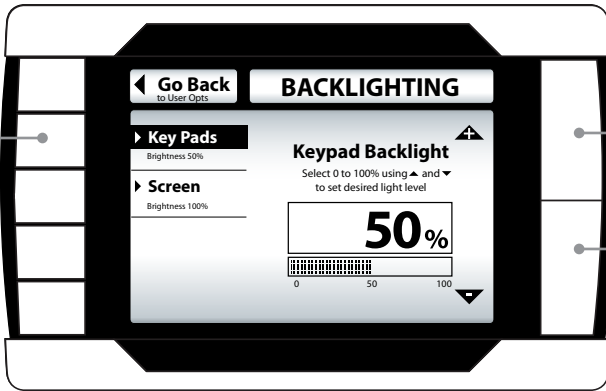

Use these buttons to adjust the backlight brightness level.

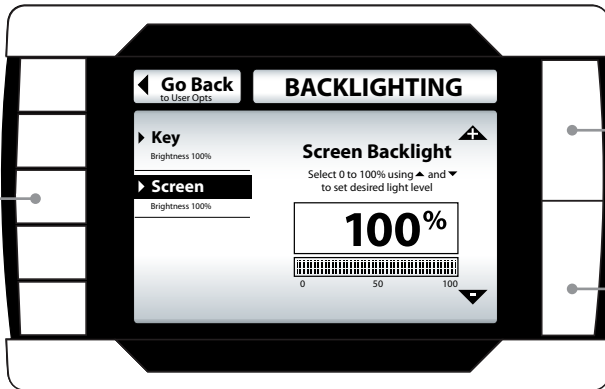

Use this button select the 'Screen' option.

## CHANGE BACKGROUND COLOR

Use the up and down buttons to select a background color. The Black Maxx background will preview each color background as you scroll up and down through the color options. When the preferred color is highlighted, exit the color menu to select the color.

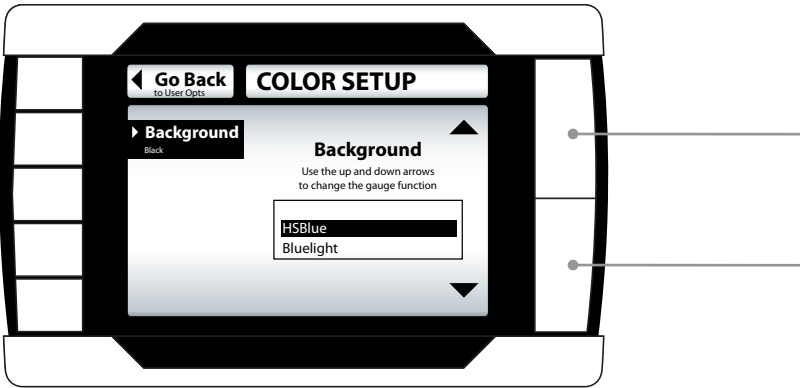

Use the large Up ▲ Down ▼ Buttons to scroll up and down through the color options.

## ADJUST VOLUME SETTING

To adjust the sound volume for button feedback, simply scroll up and down to adjust the volume from zero to one hundred.

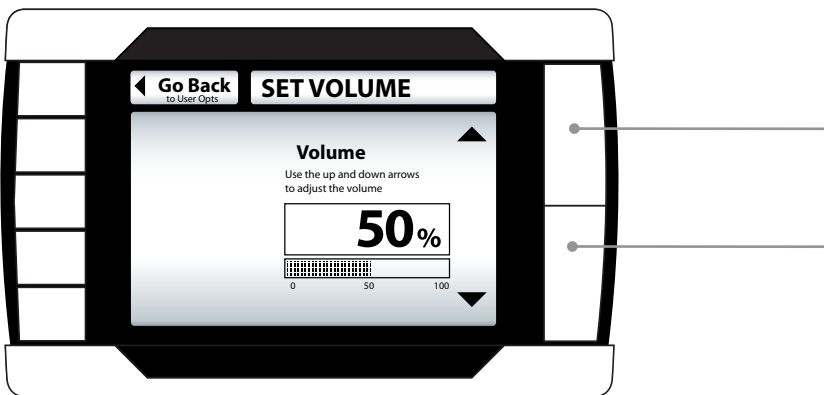

Use the large Up ▲ Down ▼ Buttons to scroll up and down through the color options.

## DIAGNOSTICS

This sub menu allows you to check vehicle Diagnostic Trouble Codes (DTCs). Upon entering this menu, the Black Maxx will automatically begin to check the vehicle for DTCs and it will then display those DTCs on the Black Maxx screen. Once it displays the DTCs value and description on the screen it will allow you to erase the DTCs from the vehicle.

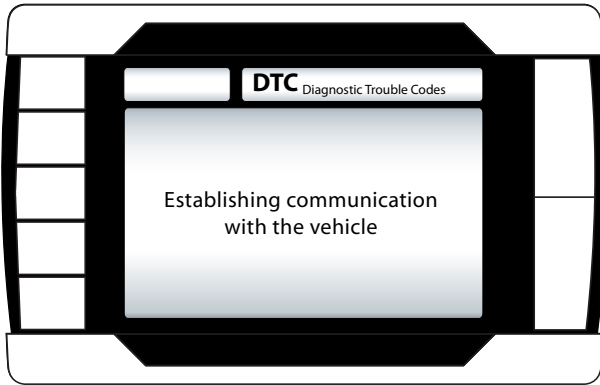

If no DTCs are displayed you can simply press the Go Back button to return to the main menu. For a complete list of DTC descriptions, please visit the Tech section of our website [www.hsperformance.com](http://www.hsperformance.com)

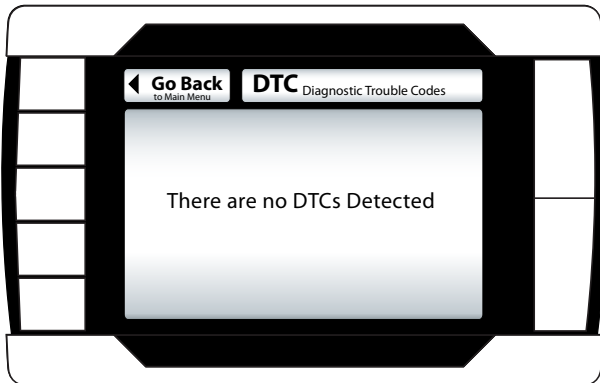

**THE SD CARD MUST BE INSERTED IN THE SIDE OF THE BLACK MAXX TO READ AND ERASE DTCs**

## RESET TO DEFAULT SETTING

To reset the Black Maxx to H&S Performance factory settings press the up button to select yes, to keep current settings back out of this menu by pressing the go back button or by pressing the down button to select no.

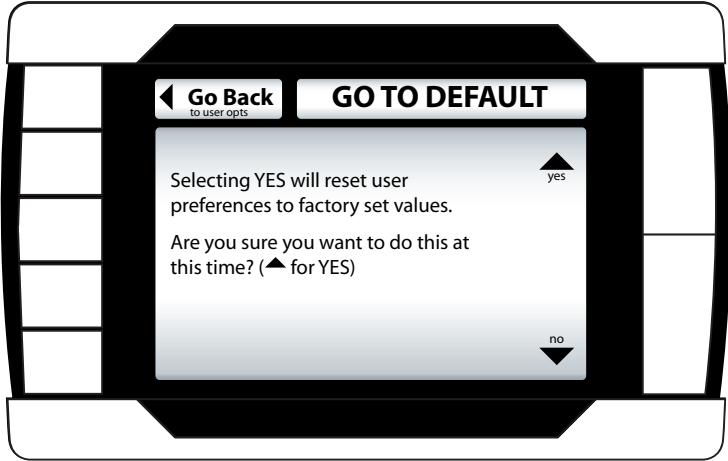

## SHOW SETTINGS

The Show Settings Menu will allow you to see vehicle information and also defuel settings. See the diagram below to see everything that is listed in this menu. On Cummins and Powerstroke trucks, the Part# and Transmission# will be needed for updating the Black Maxx.

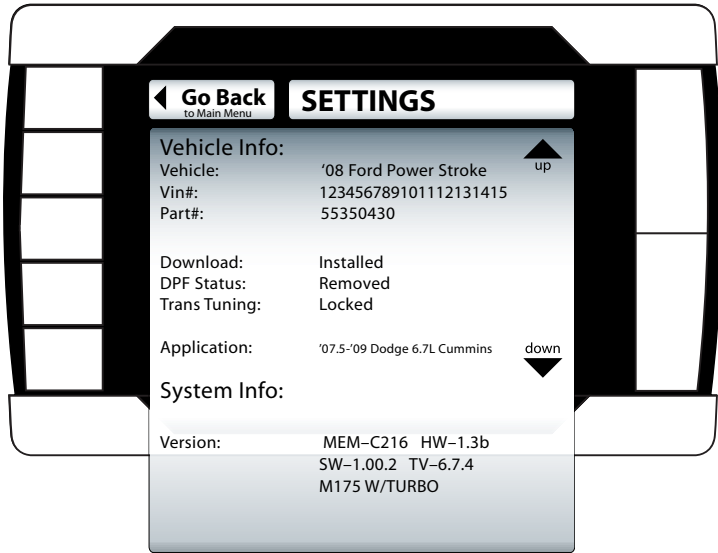

## T.V. #

This number is the Tuning Version. It will change as H&S updates the tuner software. To see the latest tuner version on your Black Maxx go to "Show Settings" and scroll down.

## SD CARD

The SD card should only be taken out of the Black Maxx to perform internet upgrades. It is the primary means of performing internet upgrades for the Black Maxx.

In case an SD Card is lost or broken, a new SD Card can be purchased from H&S Performance.

## WEB UPDATES

Remove SD card from Black Maxx. Insert SD card into included SD card reader and insert into your personal computer. Visit [www.hspower.com](http://www.hspower.com) in the downloads section for product updates. Please find your product application and follow the posted instructions there to update your Black Maxx.

## BLACK MAXX POD MOUNT

This is a diagram of a typical A-Pillar mount. Please refer to the instructions included with your custom pod.

### Custom BLACK MAXX Pod Mount Assembly Diagram

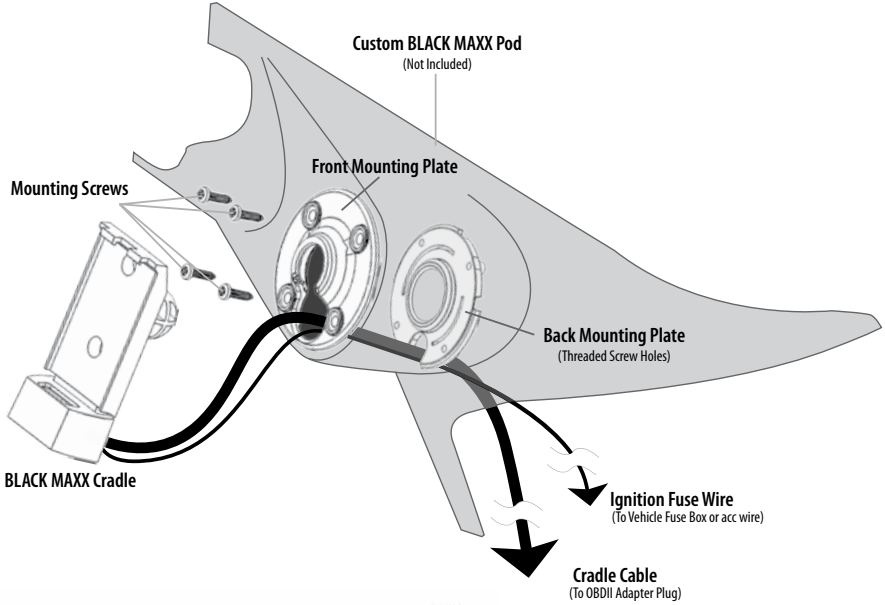

## SECTION 7: VEHICLE SPECIFIC FEATURES/INFO

### 2003 - 2007 5.9L DODGE CUMMINS

#### Power Levels

Power Levels can be adjusted on-the-fly at the touch of a button after Installing the Download to the vehicle. The current Power Level will be saved even if the Black Maxx is unplugged.

#### POWER LEVELS

No Power.....	0 HP
Mild.....	60 HP
Wild.....	120 HP
Hot.....	200 HP

**NOTE:** The Power Level ratings listed may not be exact for your particular vehicle. The listed ratings apply to the out-of-the-box tuning that H&S tuning devices are shipped with. Any custom downloads may result in different ratings and can be found at [www.hsperformance.com/black-maxx-downloads](http://www.hsperformance.com/black-maxx-downloads).

#### Low Boost Fueling

This option allows for adjustment of the amount of fuel injected under low boost conditions. There are 5 different settings for Low Boost Fueling:

- 0 - Lowest Fueling (Default)**
- 1 - Low Fueling**
- 2 - Medium Fueling**
- 3 - Moderate Fueling**
- 4 - High Fueling**

**NOTE:** The low boost fueling adjustment will affect ALL power levels. This option can only be adjusted during the Install Download process.

#### Injection Timing

This option allows for the adjustment of the maximum allowed injection timing. There are 5 different settings for the Injection Timing:

- 0 - 18 degrees**
- 1 - 24 degrees**
- 2 - 26 degrees (Default)**
- 3 - 28 degrees**
- 4 - 32 degrees**

**NOTE:** The injection timing adjustment will affect ALL power levels. This option can only be adjusted during the Install Download process.

## Speed Limiter

This option allows for the adjustment of the factory speed limiter. Most 5.9L Cummins trucks have a 106 MPH speed limiter from the factory. The limiter can be adjusted from 50 MPH to 200 MPH. This option can only be adjusted during the Install Download process.

## Rev Limiter

This option allows for the adjustment of the factory rev limiter. Most 5.9L Cummins trucks have a 3500 RPM rev limiter from the factory. The limiter can be adjusted from 3000 RPM to 5000 RPM. This option can only be adjusted during the Install Download process.

## Torque Management (Automatic Transmission Only)

This option allows for the disabling of the vehicles torque management for those equipped with automatic transmissions. This is recommend for those running standalone aftermarket TCM/transmission packages but will also slightly improve throttle response on a stock truck.

**NOTE:** *By turning the torque management OFF, the PRNDL display will be lost.*

## Tire Size Calibration

This option allows for the re-calibration of the factory speedometer to adjust for non-stock sized tires. For the most accurate speedometer reading when using non-stock sized tires, it is best to measure the diameter of the tire using a tape measure rather than going by the printed tire size. In addition, using a GPS is a great way to dial in your factory speedometer. Entering a larger tire size will cause the factory speedometer to read higher while entering a smaller tire size will cause the factory speedometer to read lower. The tire size can be adjusted from 24" to 42". This option only takes a few seconds to change and can be adjusted at any time from the Tire Size Calibration menu.

## Keyed Ignition Source Location

Although it is possible to manually power up the Black Maxx without using a keyed ignition source, it can sometimes create communication issues between the Black Maxx and the vehicles ECM. To eliminate these problems, we highly recommend tapping into a 12V keyed ignition source to supply power to the Black Maxx only when the key is in the ON position and the vehicles ECM is online. Below you will find a commonly used 12V keyed ignition source for your vehicle:



### 2006-2007 5.9L - FUSE NUMBER 30

Always tap into the **cold** side of the fuse. On the 2006 - 2007 5.9L Cummins, the **cold** side is towards the drivers side of the vehicle.



### 2003 - 2005 5.9L - FUSE NUMBER 50

Always tap into the **cold** side of the fuse. On the 2003 - 2005 5.9L Cummins, the **cold** side is towards the front of the vehicle.

**NOTE:** If your fuse box or wiring looks different than those pictured or if you are not getting 12V ignition power from the pictured source, you may need to find another 12V keyed ignition source using a test

light or multimeter. If possible, find one that stays **hot** during engine cranking.

### Pyrometer (EGT) Location

If you are installing an optional H&S pyrometer kit on your 5.9L Cummins, you have the option of installing it pre-turbo or post-turbo (or both if you purchased an additional thermocouple).

For the most accurate EGT readings, we recommend installing the pyrometer pre-turbo where all runners collect on the exhaust manifold as seen below:

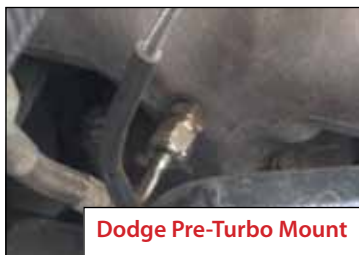

**NOTE:** Some exhaust manifolds have a divider down the center of the collector so it's generally not a good idea to drill right in the center, shift to either side 1/4" and drill there.

For those wanting to install the pyrometer post-turbo, we usually recommend doing so in the cast elbow connected to the turbo as seen below:



**NOTE:** Post-turbo EGT readings can be up to 400 degrees cooler than pre-turbo EGT readings. Keep that in mind when monitoring your EGTs with a post-turbo pyrometer.

## Overdrive Transmission Software

Did you know that your H&S tuning device also has the capability of tuning your transmission? If your 5.9L Cummins is equipped with the 48RFE automatic transmission, you may want to check out our Overdrive Transmission Software. Custom tailored to mate with H&S engine tuning, the 5.9L Overdrive software includes modified torque converter lock/unlock strategies that will command the TC to lock in 3rd gear under wide open throttle and hold it locked through 4th gear. Light throttle torque converter strategies have also been changed to lock-up sooner, keeping more power directed to the road instead of wasted in heat and friction. Shift points are modified to take advantage of the available horsepower and torque output. On a 2006 Cummins with a stock 48RFE, we have seen 0.2 to 0.3 second quicker 1/4 mile times JUST from the addition of the H&S Overdrive tuning! An additional unlock fee may apply, see [www.hsperformance.com](http://www.hsperformance.com) for details.

## 2007.5 - 2009 6.7L DODGE CUMMINS

### Power Levels

Power Levels can be adjusted on-the-fly at the touch of a button after Installing the Download to the vehicle. The unit cannot be unplugged otherwise the Power Level will default to NO POWER.

**NOTE:** The Power Level ratings listed may not be exact for your particular vehicle. The listed ratings apply to the out-of-the-box tuning that H&S tuning devices are shipped with. Any custom downloads may result in different ratings and can be found at [www.hsperformance.com/black-maxx-downloads](http://www.hsperformance.com/black-maxx-downloads).

<b>POWER LEVELS</b>	
<b>DPF PRESENT</b>	
No Power.....	0 HP
Mild.....	40 HP
Wild.....	80 HP
Hot.....	120 HP

### DPF Selection

The DPF or Diesel Particulate Filter is part of the factory exhaust system on the 6.7L Cummins. H&S offers tuning that allows the DPF to be left in place, or removed completely.

If you are planning on leaving the exhaust system stock with the DPF in place, you will select PRESENT.

If you have already removed the DPF or if you plan on removing the DPF immediately after installing your H&S tuning device, you will select REMOVED. If you select REMOVED, you must Accept our DPF Disclaimer in order to continue with the Install Download process.

<b>POWER LEVELS</b>	
<b>DPF REMOVED</b>	
No Power.....	0 HP
Mild.....	60 HP
Wild.....	120 HP
Hot.....	175 HP

### DPF / Exhaust Sensors

When running DPF PRESENT tuning, it is required that all sensors located in the exhaust system stay in place and plugged in, otherwise you may experience a Check Engine Light

(CEL) and even a loss of power (limp mode).

When running DPF REMOVED tuning, it is recommended that all sensors located in the factory exhaust system be unplugged from the electrical harnesses. These sensors can also be removed completely with the factory exhaust if desired. On the 2007.5 - 2009 6.7L Cummins, there are usually 3 EGT Sensors, 2 O2 Sensors, and 1 Pressure Sensor.

### EGR Unplug / Delete

If you are installing H&S DPF REMOVED tuning, you must unplug the EGR system on your 2007.5 - 2009 6.7L Cummins if not installing an EGR delete. Failing to do so may result in erratic engine operation and loss of power. Please follow these instructions carefully to unplug and disable the EGR system:

1. Locate the EGR Throttle Control Valve Assembly (Fig.1). Assembly is located between the inter-cooler and intake manifold on the drivers side of the engine compartment.
2. Unplug the EGR Throttle Control Valve wiring harness. The harness is LIGHT GRAY in color and is located on the back side of the Throttle Control Valve Assembly. It is not directly visible when looking at the assembly from above. On some vehicles, it may be easier to see and unplug the harness from underneath the vehicle. Note: There is a red locking tab that must be moved sideways on the harness in order for it to be unplugged.
3. Locate the EGR solenoid on top of the intake manifold (Fig.2). It is directly visible when looking at the intake manifold and faces towards the front of the vehicle.
4. Unplug the EGR solenoid wiring harness. The connector is BROWN in color.



### Speed Limiter

This option allows for the adjustment of the factory speed limiter. Most 6.7L Cummins trucks have a 106 MPH speed limiter from the factory. The limiter can be adjusted from 55 MPH to 200 MPH. This option can only be adjusted during the Install Download process.

### Tire Size Calibration

This option allows for the re-calibration of the factory speedometer to adjust for non-stock sized tires. For the most accurate speedometer reading when using non-stock sized tires, it is best to measure

the diameter of the tire using a tape measure rather than going by the printed tire size. In addition, using a GPS is a great way to dial in your factory speedometer. Entering a larger tire size will cause the factory speedometer to read higher while entering a smaller tire size will cause the factory speedometer to read lower. The tire size can be adjusted from 25.5" to 45". This option only takes a few seconds to change and can be adjusted at any time from the Tire Pressure Calibration menu.

## Special Functions / Features

Your H&S tuning device has the capability of Enabling / Disabling factory vehicle features. These features can be found in the Special Functions Menu. Below is a short description of each feature:

**TPMS:** Enable / Disable the Tire Pressure Monitoring System.

**Optical Chirp on Lock:** Enable / Disable the parking lights flashing when locking the vehicle.

**Horn Chirp on Lock:** Enable / Disable the horn chirp when locking the vehicle.

**Set Headlamp Delay:** Enable / Disable the headlamp delay.

**Accessory Delay:** Enable / Disable the shut-off delay of your radio and accessory system after the key has been turned off.

**Fog Lights W/High:** Enable / Disable the fog lights staying on when high beams are being used.

**Daytime Lights:** Enable / Disable the daytime running lights.

**Seat Belt Minder:** Enable / Disable the chime for the drivers seat belt system. This feature will not disable the seat belt light.

**Auto Door Lock:** Enable / Disable the automatic door locking when the vehicle reaches certain speeds.

**Unlock Driver Door:** Enable / Disable unlocking only the driver door when pushing the unlock button the key-fob. When enabled, the unlock button on the key fob will need to be pressed twice in order to unlock all doors.

**Idle Up (Auto Only):** Enable / Disable the use of the cruise control buttons to control idle RPM. Follow your vehicle owners manual to use this feature

**NOTE:** *If any special feature is already listed as Enabled but is not functioning correctly, you may need to disable the feature, cycle the key, and re-enable the feature to make it function properly. If it still does not work, your vehicle may not be equipped with the hardware required for the special feature. The previous selection will NOT be saved. If the Special Functions/Features Menu is exited and returned into, it will not display your previous selection. This is normal and the Enable/Disable function is still working properly.*

## Keyed Ignition Source Location

Although it is possible to manually power up the Black Maxx without using a keyed ignition source, it can sometimes create communication issues between the Black Maxx and the vehicles ECM. To eliminate these problems, we highly recommend tapping into a 12V keyed ignition source to supply power to the Black Maxx only when the key is in the ON position and the vehicles ECM is online. Below you will find a commonly used 12V keyed ignition source for your vehicle:



### FUSE NUMBER 30

Always tap into the **cold** side of the fuse. On the 2007.5 - 2009 6.7L Cummins, the **cold** side is towards the drivers side of the vehicle.

**NOTE:** If your fuse box or wiring looks different than those pictured or if you are not getting 12V ignition power from the pictured source, you may need to find another 12V keyed ignition source using a test

light or multimeter. If possible, find one that stays **hot** during engine cranking.

### Pyrometer (EGT) Location:

If you are installing an optional H&S pyrometer kit on your 6.7L Cummins, you have the option of installing it pre-turbo or post-turbo (or both if you purchased an additional thermocouple).

For the most accurate EGT readings, we recommend installing the pyrometer pre-turbo where all runners collect on the exhaust manifold as seen below:



**NOTE:** Some exhaust manifolds have a divider down the center of the collector so it's generally not a good idea to drill right in the center, shift to either side 1/4" and drill there.

For those wanting to install the pyrometer post-turbo, we usually recommend doing so in the cast elbow connected to the turbo as seen below:



**NOTE:** Post-turbo EGT readings can be up to 400 degrees cooler than pre-turbo EGT readings. Keep that in mind when monitoring your EGTs with a post-turbo pyrometer.

### Overdrive Transmission Software

Did you know that your H&S tuning device also has the capability of tuning your transmission? If your 6.7L Cummins is equipped with the 68RFE automatic transmission, you may want to check out our Overdrive Transmission Software. Custom tailored to mate with H&S engine tuning, the 6.7L Overdrive software includes boosted line pressures, modified full and part throttle torque

converter lock/unlock strategies, adjusted full and part throttle shift points, adjusted full and part throttle shift firmness, modified torque management tables, and much more! All changes are designed to keep more power directed to the road instead of wasted in heat and friction. On our test trucks, we have seen 0.2 to 0.3 second quicker 1/4 mile times JUST from the addition of the H&S Overdrive tuning! An additional unlock fee may apply, see [www.hsperformance.com](http://www.hsperformance.com) for details.

## 2010 - 2011 6.7L DODGE CUMMINS

### Power Levels

Power Levels can be adjusted on-the-fly at the touch of a button after installing the Download to the vehicle. The unit cannot be unplugged otherwise the Power Level will default to NO POWER.

**NOTE:** *The Power Level ratings listed may not be exact for your particular vehicle. The listed ratings apply to the out-of-the-box tuning that H&S tuning devices are shipped with. Any custom downloads may result in different ratings and can be found at [www.hsperformance.com/black-maxx-downloads](http://www.hsperformance.com/black-maxx-downloads).*

### DPF Selection

The DPF or Diesel Particulate Filter is part of the factory exhaust system on the 6.7L Cummins.

H&S offers tuning that allows the DPF to be left in place, or removed completely.

If you are planning on leaving the exhaust system stock with the DPF in place, you will select PRESENT.

If you have already removed the DPF or if you plan on removing the DPF immediately after installing your H&S tuning device, you will select REMOVED. If you select REMOVED, you must Accept our DPF Disclaimer in order to continue with the Install Download process.

### DPF / Exhaust Sensors

When running DPF PRESENT tuning, it is required that all sensors located in the exhaust

#### 2010-2011 PICKUP POWER LEVELS DPF PRESENT

No Power .....	0 HP
Mild .....	40 HP
Wild .....	80 HP
Hot .....	120 HP

#### 2011 CAB & CHASSIS POWER LEVELS DPF PRESENT

No Power .....	0 HP
Mild .....	20 HP
Wild .....	40 HP
Hot .....	60 HP

#### 2010-2011 PICKUP POWER LEVELS DPF REMOVED

No Power .....	0 HP
Mild .....	60 HP
Wild .....	120 HP
Hot .....	175 HP

#### 2011 CAB & CHASSIS POWER LEVELS DPF REMOVED

No Power .....	0 HP
Mild .....	25 HP
Wild .....	50 HP
Hot .....	75 HP

system stay in place and plugged in, otherwise you may experience a Check Engine Light (CEL) and even a loss of power (limp mode).

When running DPF REMOVED tuning, it is recommended that all sensors located in the factory exhaust system be unplugged from the electrical harnesses. These sensors can also be removed completely with the factory exhaust if desired. On the 2010 - 2011 Pickup, there are usually 3 EGT Sensors, 2 O2 Sensors, and 1 Pressure Sensor.

### 2011 Cab & Chassis UREA System

On the 2011 Cab & Chassis, there is usually an additional NOX sensor as well as a UREA system that needs to be unplugged when running DPF REMOVED tuning. The UREA system must at least be unplugged but can be completely removed from the vehicle if desired. Failure to unplug the UREA system may result in a check engine light and/or dash messages. Follow these instructions to unplug the UREA system:

1. Locate the wiring harness with the YELLOW sliding lock-tab on the Urea pump assembly. The pump assembly is located near the bottom of the filler neck support.



2. Slide the yellow lock-tab DOWN to dis-engage the lock and unplug the harness.



For complete UREA System Removal instructions, visit [www.hperformance.com/tech/CCUrea.pdf](http://www.hperformance.com/tech/CCUrea.pdf).

### EGR Unplug / Delete

Unlike the previous years, it is no longer mandatory to unplug the EGR system when install-

ing H&S DPF REMOVED tuning. You may still unplug the EGR system if desired, or the EGR system may be left plugged in without any ill effects. The entire EGR system can also be completely removed with an H&S EGR Delete Kit when running H&S DPF REMOVED tuning.

### Speed Limiter

This option allows for removal of the factory speed limiter. Most 6.7L Cummins trucks have a 106 MPH speed limiter from the factory. This option can only be changed during the Install Download process.

### Torque Management (Manual Transmission Only)

This option allows for the disabling of the vehicles torque management for those equipped with manual transmissions. This option increases pedal sensitivity and throttle response when REMOVED.

### Tire Size Calibration

This option allows for the re-calibration of the factory speedometer to adjust for non-stock sized tires. For the most accurate speedometer reading when using non-stock sized tires, it is best to measure the diameter of the tire using a tape measure rather than going by the printed tire size. In addition, using a GPS is a great way to dial in your factory speedometer. Entering a larger tire size will cause the factory speedometer to read higher while entering a smaller tire size will cause the factory speedometer to read lower. The tire size can be adjusted from 25.5" to 45". This option can only be seen/changed after the Download is Installed to the vehicle. This option only takes a few seconds to change and can be adjusted at any time from the Tire Size Calibration menu.

### Special Functions / Features

Your H&S tuning device has the capability of Enabling / Disabling factory vehicle features. These features can be found in the Special Functions Menu. These features can only be seen/changed after the Download is Installed to the vehicle. Below is a short description of each feature:

**TPMS:** Enable / Disable the Tire Pressure Monitoring System.

**Optical Chirp on Lock:** Enable / Disable the parking lights flashing when locking the vehicle.

**Horn Chirp on Lock:** Enable / Disable the horn chirp when locking the vehicle.

**Set Headlamp Delay:** Enable / Disable the headlamp delay.

**Accessory Delay:** Enable / Disable the shut-off delay of your radio and accessory system after the key has been turned off.

**Fog Lights W/High:** Enable / Disable the fog lights staying on when high beams are being used.

**Daytime Lights:** Enable / Disable the daytime running lights.

**Seat Belt Minder:** Enable / Disable the chime for the drivers seat belt system. This feature will not disable the seat belt light.

**NOTE:** If any special feature is already listed as Enabled but is not functioning correctly, you may need to disable the feature, cycle the key, and re-enable the feature to make it function properly. If it still does not work, your vehicle may not be equipped with the hardware required for the special feature. The previous selection will NOT be saved. If the Special Functions/Features Menu is exited and returned into, it will not display your previous selection. This is normal and the Enable/Disable function is still working properly.

### Stationary Idle Adjust:

The Stationary Idle Adjust Menu will allow you to adjust the idle speed of your vehicle while in Park or Neutral using your H&S tuning device. Choose the desired idle speed and select **Set** to set the idle speed to the chosen RPM. Idle speed can be adjusted from 700 RPM to 1500 RPM.

### Keyed Ignition Source Location

Although it is possible to manually power up the Black Maxx without using a keyed ignition source, it can sometimes create communication issues between the Black Maxx and the vehicles ECM. To eliminate these problems, we highly recommend tapping into a 12V keyed ignition source to supply power to the Black Maxx only when the key is in the ON position and the vehicles ECM is online. Below you will find a commonly used 12V keyed ignition source for your vehicle:

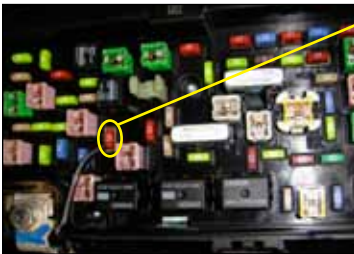

#### 2010 6.7L Pickup and 2011 6.7L Cab & Chassis FUSE NUMBER M45

Always tap into the **cold** side of the fuse. On the 2010 Pickup and 2011 Cab & Chassis, the **cold** side is towards the front of the vehicle.



#### 2011 6.7L Pickup FUSE NUMBER M33

Always tap into the **cold** side of the fuse. On the 2011 Pickup, the **cold** side is towards the front of the vehicle.

**NOTE:** If your fuse box or wiring looks different than those pictured or if you are not getting 12V ignition power from the pictured source, you may need to find another 12V keyed ignition source using a test light or multimeter. If possible, find one that stays **hot** during engine cranking.

## Pyrometer (EGT) Location

If you are installing an optional H&S pyrometer kit on your 6.7L Cummins, you have the option of installing it pre-turbo or post-turbo (or both if you purchased an additional thermocouple).

For the most accurate EGT readings, we recommend installing the pyrometer pre-turbo where all runners collect on the exhaust manifold as seen below:



Dodge Pre-Turbo Mount

**NOTE:** Some exhaust manifolds have a divider down the center of the collector so it's generally not a good idea to drill right in the center, shift to either side 1/4" and drill there.

For those wanting to install the pyrometer post-turbo, we usually recommend doing so in the cast elbow connected to the turbo as seen below:



Dodge Post-Turbo Mount

**NOTE:** Post-turbo EGT readings can be up to 400 degrees cooler than pre-turbo EGT readings. Keep that in mind when monitoring your EGTs with a post-turbo pyrometer.

## Overdrive Transmission Software

Did you know that your H&S tuning device also has the capability of tuning your transmission? If your 6.7L Cummins is equipped with the 68RFE Automatic Transmission, you may want to check out our Overdrive Transmission Software. Custom tailored to mate with H&S engine tuning, the 6.7L Overdrive software includes boosted line pressures, modified full and part throttle torque converter lock/unlock strategies, adjusted full and part throttle shift points, adjusted full and part throttle shift firmness, modified torque management tables, and much more! All changes are designed to keep more power directed to the road instead of wasted in heat and friction. On our test trucks, we have seen 0.2 to 0.3 second quicker 1/4 mile times JUST from the addition of the H&S Overdrive tuning! An additional unlock fee may apply, see [www.hsperformance.com](http://www.hsperformance.com) for details.

## 2003 - 2007 6.0L FORD POWERSTROKE

### Power Levels

Power Levels can be adjusted on-the-fly at the touch of a button after Installing the Download to the vehicle. The current Power Level will be saved even if the Black Maxx is unplugged.

#### POWER LEVELS

No Power.....	0 HP
Mild.....	40 HP
Wild.....	80 HP
Hot.....	120 HP

**NOTE:** *The Power Level ratings listed may not be exact for your particular vehicle. The listed ratings apply to the out-of-the-box tuning that H&S tuning devices are shipped with. Any custom downloads may result in different ratings and can be found at [www.hperformance.com/black-maxx-downloads](http://www.hperformance.com/black-maxx-downloads).*

### EGR Delete

With H&S tuning installed, the EGR system on the 6.0L Powerstroke can be completely removed with an EGR Delete Kit while remaining code free.

### Speed Limiter

This option allows for the removal of the factory speed limiter. Most 6.0L Powerstroke trucks have a 95 MPH speed limiter from the factory. The limiter can be removed completely or left stock (*this may change so be sure to visit [www.hperformance.com](http://www.hperformance.com) for product updates*). This option can only be changed during the Install Download process.

### Tire Size Calibration

*(Not currently available for the 2003 - 2007 6.0L Powerstroke. This may change so be sure to visit [www.hperformance.com](http://www.hperformance.com) for product updates)* This option allows for the re-calibration of the factory speedometer to adjust for non-stock sized tires. For the most accurate speedometer reading when using non-stock sized tires, it is best to measure the diameter of the tire using a tape measure rather than going by the printed tire size. In addition, using a GPS is a great way to dial in your factory speedometer. Entering a larger tire size will cause the factory speedometer to read higher while entering a smaller tire size will cause the factory speedometer to read lower. This option can only be adjusted during the Install Download process.

### Keyed Ignition Source Location

Although it is possible to manually power up the Black Maxx without using a keyed ignition source, it can sometimes create communication issues between the Black Maxx and the vehicles ECM. To eliminate these problems, we highly recommend tapping into a 12V keyed ignition source to supply power to the Black Maxx only when the key is in the ON position and the vehicles ECM is online. Below you will find a commonly used 12V keyed ignition source for your vehicle:



### FUSE NUMBER 15

Always tap into the **cold** side of the fuse. On the 2003 - 2007 6.0L Powerstroke, the **cold** side is towards the driver side of the vehicle.

**NOTE:** If your fuse box or wiring looks different than those pictured or if you are not getting 12V ignition power from the pictured source, you may need to find another 12V keyed ignition source using a test

light or multimeter. If possible, find one that stays **hot** during engine cranking.

### Pyrometer (EGT) Location

If you are installing an optional H&S pyrometer kit on your 6.0L Powerstroke, you have the option of installing it pre-turbo or post-turbo (or both if you purchased an additional thermocouple).

For the most accurate EGT readings, we recommend installing the pyrometer pre-turbo in the driver side exhaust manifold as seen below:

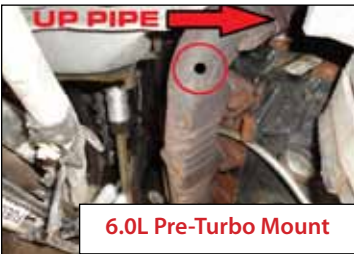

**NOTE:** The driver side exhaust manifold can be easily accessed from underneath the vehicle. Be sure to drill straight into the exhaust manifold otherwise the pyrometer probe may hit the manifold wall during installation.

For those wanting to install the pyrometer post-turbo, we usually recommend doing so somewhere in the downpipe.

**NOTE:** The downpipe is pretty thin in most places, so be extra careful when tapping and installing the probe fitting. Post-turbo EGT readings can be up to 400 degrees cooler than pre-turbo EGT readings. Keep that in mind when monitoring your EGTs with a post-turbo pyrometer.

## 2008 - 2010 6.4L FORD POWERSTROKE

### Power Levels

Power Levels can be adjusted on-the-fly at the touch of a button after Installing the Download to the vehicle. The current Power Level will be saved even if the Black Maxx is unplugged.

**NOTE:** *The Power Level ratings listed may not be exact for your particular vehicle. The listed ratings apply to the out-of-the-box tuning that H&S tuning devices are shipped with. Any custom downloads may result in different ratings and can be found at [www.hsperformance.com/black-maxx-downloads](http://www.hsperformance.com/black-maxx-downloads).*

### DPF Selection

The DPF or Diesel Particulate Filter is part of the factory exhaust system on the 6.4L Powerstroke. H&S offers tuning that allows the DPF to be left in place, or removed completely.

If you are planning on leaving the exhaust system stock with the DPF in place, you will select PRESENT.

If you have already removed the DPF or if you plan on removing the DPF immediately after installing your H&S tuning device, you will select REMOVED. If you select REMOVED, you must Accept our DPF Disclaimer in order to continue with the Install Download process.

### DPF / Exhaust Sensors

When running DPF PRESENT tuning, it is required that all sensors located in the exhaust system stay in place and plugged in, otherwise you may experience a Check Engine Light (CEL) and even a loss of power (limp mode).

When running DPF REMOVED tuning, it is recommended that all sensors located in the factory exhaust system be unplugged from the electrical harnesses. These sensors can also be removed completely with the factory exhaust if desired. On the 6.4L Powerstroke, there are usually 2 EGT Sensors and 1 Pressure Sensor.

**NOTE:** *The vehicle will not run with sensors removed unless DPF REMOVED tuning is installed.*

### EGR Unplug / Delete

When running H&S DPF REMOVED tuning, it is not required to unplug or block-off the EGR

#### POWER LEVELS DPF PRESENT

No Power.....	0 HP
Mild.....	40 HP
Wild.....	80 HP
Hot.....	120 HP

#### POWER LEVELS DPF REMOVED

No Power.....	0 HP
Mild.....	80 HP
Wild.....	160 HP
Hot.....	250 HP

system on your 6.4L Powerstroke to disable it. The EGR system is already disabled in the tuning and will not function under any conditions. If desired, the entire EGR system can be unplugged, blocked-off, or completely removed when running H&S DPF REMOVED tuning.

### Speed Limiter

This option allows for the adjustment of the factory speed limiter. Most 6.4L Powerstroke trucks have a 95 MPH speed limiter from the factory. The limiter can be adjusted from 55 MPH to 200 MPH. This option can only be adjusted during the Install Download process.

### Tire Size Calibration

This option allows for the re-calibration of the factory speedometer to adjust for non-stock sized tires. For the most accurate speedometer reading when using non-stock sized tires, it is best to measure the diameter of the tire using a tape measure rather than going by the printed tire size. In addition, using a GPS is a great way to dial in your factory speedometer. Entering a larger tire size will cause the factory speedometer to read higher while entering a smaller tire size will cause the factory speedometer to read lower. The tire size can be adjusted from 25" to 45". This option can only be adjusted during the Install Download process.

### TPMS Adjustability / Disable

Many 2008 - 2010 6.4L Powerstrokes are equipped with a TPMS or Tire Pressure Monitoring System from the factory. This system is designed to alert the driver of a problem with the vehicles tire pressures but is often a nagging inconvenience for those individuals wanting to run lower pressures or get rid of the TPMS sensors altogether.

H&S Performance has a designed solution for those individuals. By using your H&S tuning device and a 6.4L Powerstroke TPMS Adapter (Part #709913), you will have full control of the TPMS. Front and rear tire pressures will be independently adjustable from 0 - 100 PSI as well as the option to Disable the TPMS completely if removing the TPMS sensors from the vehicle. All changes to the TPMS must be done with the 6.4L Powerstroke TPMS Adapter in place and the Adapter must be removed after changes are made to resume normal tuner function.

### Transmission Relearn

The 5R110 automatic transmission on the 2008 - 2010 6.4L Powerstroke has what is called **Adaptive Memory** and is constantly learning and adapting to different horsepower levels, temperatures, driving habits, etc. After completing the Install Download process on the 6.4L Powerstroke, the Transmission Adaptive Memory is automatically reset. We highly recommend performing a Transmission Relearn procedure after installing H&S tuning to help the

transmission perform correctly with the added horsepower. The 5R110 automatic transmission will eventually learn over time on its own, but the relearn procedure gives a good baseline for the adaptive learning and helps to speed up the learning process. To perform the relearn procedure, please follow these instructions:

**When re-training the transmission, ALWAYS follow posted speed limits. Do NOT attempt runs in adverse weather conditions such as snow, ice, rain, wind, or any other conditions that may affect your vehicles traction or impair your visibility!**

1. After H&S tuning is installed, perform each of the following 0-80 MPH runs while in the **HOT** power level. During this relearn process, you may experience hesitation during shifts, hard shifts, or defuel patterns, all of which are normal:
  - **0-80 MPH @ 25% throttle position, then slow down and come to a complete stop.**
  - **0-80 MPH @ 50% throttle position, then slow down and come to a complete stop.**
  - **0-80 MPH @ 100% throttle position, then slow down and come to a complete stop.**

**The Transmission Relearn procedure is complete.**

**NOTE:** *On any vehicle using 3" or larger lift blocks under the rear leaf pack, it is HIGHLY RECOMMENDED to install traction bars. With any added horsepower, failure to do so may result in harsh shifting and may cause premature transmission and/or driveline damage.*

### Keyed Ignition Source Location

Although it is possible to manually power up the Black Maxx without using a keyed ignition source, it can sometimes create communication issues between the Black Maxx and the vehicles ECM. To eliminate these problems, we highly recommend tapping into a 12V keyed ignition source to supply power to the Black Maxx only when the key is in the ON position and the vehicles ECM is online. Below you will find a commonly used 12V keyed ignition source for your vehicle:



#### SOLID PURPLE WIRE

The SOLID PURPLE wire (capped from the factory) is found under the drivers side dash. This SOLID PURPLE wire is bundled with multiple other capped wires near the OBD-II port.

**NOTE:** *If your fuse box or wiring looks different than those pictured or if you are not getting 12V ignition power from the pictured source, you may need to find another 12V keyed ignition source using a test light or multimeter. If possible, find one that stays "hot" during engine cranking.*

## Pyrometer (EGT) Location

On the 6.4L Powerstroke, the Black Maxx takes advantage of a factory EGT sensor located in the passenger side up-pipe. This factory sensor gives very accurate pre-turbo EGT readings so no aftermarket pyrometer is needed although you may purchase and install additional pyrometers to monitor pre-turbo and post-turbo temperatures if desired.

## 2011-2012 6.7L FORD POWERSTROKE

### Power Levels

Power Levels can be adjusted on-the-fly at the touch of a button after Installing the Download to the vehicle. The unit cannot be unplugged otherwise the Power Level will default to NO POWER.

**NOTE:** *The Power Level ratings listed may not be exact for your particular vehicle. The listed ratings apply to the out-of-the-box tuning that H&S tuning devices are shipped with. Any custom downloads may result in different ratings and can be found at [www.hsperformance.com/black-maxx-downloads](http://www.hsperformance.com/black-maxx-downloads).*

### DPF Selection

The DPF or Diesel Particulate Filter is part of the factory exhaust system on the 6.7L Powerstroke. H&S offers tuning that allows the DPF to be left in place, or removed completely.

If you are planning on leaving the exhaust system stock with the DPF in place, you will select PRESENT.

If you have already removed the DPF or if you plan on removing the DPF immediately after installing your H&S tuning device, you will select REMOVED. If you select REMOVED, you must Accept our DPF Disclaimer in order to continue with the Install Download process.

### DPF / Exhaust Sensors

When running DPF PRESENT tuning, it is required that all sensors located in the exhaust system stay in place and plugged in, otherwise you may experience a Check Engine Light (CEL) and even a loss of power (limp mode).

When running DPF REMOVED tuning, it is recommended that all sensors located in the factory exhaust system be unplugged from the electrical harnesses. These sensors can also be

#### POWER LEVELS DPF PRESENT

No Power .....	0 HP
Mild .....	40 HP
Wild .....	80 HP
Hot .....	120 HP

\*An additional unlock fee may apply for DPF Present tuning.

#### POWER LEVELS DPF REMOVED

No Power .....	0 HP
Mild .....	50 HP
Wild .....	100 HP
Hot .....	150 HP

\*An additional unlock fee may apply for DPF Removed tuning.

removed completely with the factory exhaust if desired. On the 6.7L Powerstroke, there are usually 3 EGT Sensors, 1 NOX Sensor, 1 UREA Injector, and 1 Pressure Sensor.

**NOTE:** *The vehicle will not run with sensors removed unless DPF REMOVED tuning is installed.*

### UREA / SCR System

On the 2011 - 2012 6.7L Powerstroke, there is a UREA system that can be unplugged or removed completely when running DPF REMOVED tuning. The UREA system may also be left plugged in with no ill effects.

### EGR Unplug / Delete

If you are installing H&S DPF REMOVED tuning, you must unplug the EGR system on your 2011-2012 6.7L Powerstroke if not installing an EGR delete. Failing to do so may result in damage to your EGR parts.

Please follow these instructions carefully to unplug and disable the EGR system:

1. Unplug Orange EGR harness found on top of the EGR cooler assembly. The yellow lock tab must be slid out before the harness can be unplugged.



2. Unplug the EGR Butterfly Valve located near the radiator fan shroud.



## Speed Limiter

This option allows for the adjustment of the factory speed limiter. Most 6.7L Powerstroke trucks have a 98 MPH speed limiter from the factory. The limiter can be changed to 75 MPH or removed completely (*this may change so be sure to visit [www.hsperformance.com](http://www.hsperformance.com) for product updates*). This option can only be changed during the Install Download process.

## Tire Size Calibration

This option allows for the re-calibration of the factory speedometer to adjust for non-stock sized tires. For the most accurate speedometer reading when using non-stock sized tires, it is best to measure the diameter of the tire using a tape measure rather than going by the printed tire size. In addition, using a GPS is a great way to dial in your factory speedometer. Entering a larger tire size will cause the factory speedometer to read higher while entering a smaller tire size will cause the factory speedometer to read lower. The tire size can be adjusted from 31" to 34" (*this may change so be sure to visit [www.hsperformance.com](http://www.hsperformance.com) for product updates*). This option only takes a few seconds to change and can be adjusted at any time from the Tire Size Calibration menu.

## TPMS Adjustability / Disable

Many 2011 - 2012 6.7L Powerstrokes are equipped with a TPMS or Tire Pressure Monitoring System from the factory. This system is designed to alert the driver of a problem with the vehicles tire pressures but is often a nagging inconvenience for those individuals wanting to run lower pressures or get rid of the TPMS sensors altogether.

With your H&S tuning device, you have full control of the TPMS. Front and rear tire pressures are independently adjustable from 0-120 PSI as well as the option to disable the TPMS completely if removing the TPMS sensors from the vehicle. This option only takes a few seconds to change and can be adjusted at any time from the Tire Pressure Calibration menu.

**NOTE:** *TPMS adjustments will not take full effect on a stationary vehicle. Once adjustments have been made, it can take up to 5 miles of driving before changes take effect.*

## Transmission Tuning

Did you know that your H&S tuning device also has the capability of tuning your transmission? Our transmission tuning for the 6R140 automatic transmission is custom tailored to mate with H&S engine tuning. Some features include: boosted line pressures, modified full and part throttle lock/unlock strategies, adjusted full and part throttle shift points, adjusted full and part throttle shift firmness, and modified torque management tables. All changes are designed to keep more power directed to the road instead of wasted in heat and friction.

On our test trucks, we have seen 0.2 to 0.3 second quicker 1/4 mile times JUST from the addition of H&S transmission tuning! An additional unlock fee may apply, see [www.hsperformance.com](http://www.hsperformance.com) for details.

## Transmission Relearn

The 6R140 automatic transmission on the 2011 - 2012 6.7L Powerstroke has what is called **Adaptive Memory** and is constantly learning and adapting to different horsepower levels, temperatures, driving habits, etc. If you selected to tune the transmission during the Install Download process, the Transmission Adaptive Memory is automatically reset when the download completes. We highly recommend performing a Transmission Relearn procedure after installing H&S transmission tuning to help the transmission perform correctly with the added horsepower. The 6R140 automatic transmission will eventually learn over time on its own, but the relearn procedure gives a good baseline for the adaptive learning and helps to speed up the learning process. To perform the relearn procedure, please follow these instructions:

**When re-training the transmission, ALWAYS follow posted speed limits. Do NOT attempt runs in adverse weather conditions such as snow, ice, rain, wind, or any other conditions that may affect your vehicles traction or impair your visibility!**

3. After H&S tuning is installed, perform each of the following 0-80 MPH runs while in the **HOT** power level. During this relearn process, you may experience hesitation during shifts, hard shifts, or defuel patterns, all of which are normal:
  - **0-80 MPH @ 25% throttle position, then slow down and come to a complete stop.**
  - **0-80 MPH @ 50% throttle position, then slow down and come to a complete stop.**
  - **0-80 MPH @ 100% throttle position, then slow down and come to a complete stop.**

**The Transmission Relearn procedure is complete.**

**NOTE:** *On any vehicle using 3" or larger lift blocks under the rear leaf pack, it is HIGHLY RECOMMENDED to install traction bars when adding additional horsepower.*

## Keyed Ignition Source Location

Although it is possible to manually power up the Black Maxx without using a keyed ignition source, it can sometimes create communication issues between the Black Maxx and the vehicles ECM. To eliminate these problems, we highly recommend tapping into a 12V keyed ignition source to supply power to the Black Maxx only when the key is in the ON position and the vehicles ECM is online. Below you will find a commonly used 12V keyed ignition source for your vehicle:



## FUSE NUMBER 52

Always tap into the **cold** side of the fuse. On the 2011 - 2012 6.7L Powerstroke, the **cold** side is towards the passengers side of the vehicle.

**NOTE:** *If your fuse box or wiring looks different than those pictured or if you are not getting 12V ignition power from the pictured source, you may need to find another 12V keyed ignition source using a test*

*light or multimeter. If possible, find one that stays **hot** during engine cranking.*

## Pyrometer (EGT) Location

Unlike the 6.4L Powerstroke, there is no factory EGT sensor to get a reading from on the 6.7L Powerstroke when running DPF REMOVED tuning. Also, due to the reverse head flow design, there are few options for mounting an aftermarket pyrometer pre-turbo. H&S offers a couple solutions for this problem:

1. **H&S EGT KIT (Part #302202):** For those not wanting to get rid of the entire EGR system just yet, this is a cheap, easy way to get accurate EGT readings. This kit includes two block-off plates - one for the EGR exhaust inlet and one for the EGR exhaust manifold outlet. A bung is pre-welded on the exhaust manifold block-off plate that allows you to install one of the EGT sensors from the DPF system into the passenger side exhaust manifold. Full color instructions are included with the kit, see [www.hsperformance.com/store](http://www.hsperformance.com/store) for more information.
2. **H&S EGR DELETE KIT (Part #302201):** The H&S EGR Delete Kit for the 2011 - 2012 6.7L Powerstroke comes with everything you need to remove the entire EGR system from the vehicle and includes a pre-welded bung on the exhaust manifold block-off plate that allows you to install one of the EGT sensors from the DPF system into the passenger side exhaust manifold. Full color instructions are included with the kit, see [www.hsperformance.com/store](http://www.hsperformance.com/store) for more information.



## 2007.5-2010 6.6L LMM DURAMAX

### Power Levels

Power Levels can be adjusted on-the-fly at the touch of a button after Installing the Download to the vehicle. The current Power Level will be saved even if the Black Maxx is unplugged.

**NOTE:** The Power Level ratings listed may not be exact for your particular vehicle. The listed ratings apply to the out-of-the-box tuning that H&S tuning devices are shipped with. Any custom downloads may result in different ratings and can be found at [www.hsperformance.com/black-maxx-downloads](http://www.hsperformance.com/black-maxx-downloads).

### DPF Selection

The DPF or Diesel Particulate Filter is part of the factory exhaust system on the 6.6L LMM Duramax. H&S offers tuning that allows the DPF to be left in place, or removed completely.

If you are planning on leaving the exhaust system stock with the DPF in place, you will select PRESENT.

If you have already removed the DPF or if you plan on removing the DPF immediately after installing your H&S tuning device, you will select REMOVED. If you select REMOVED, you must Accept our DPF Disclaimer in order to continue with the Install Download process.

### DPF / Exhaust Sensors

When running DPF PRESENT tuning, it is required that all sensors located in the exhaust system stay in place and plugged in, otherwise you may experience a Check Engine Light (CEL) and even a loss of power (limp mode).

When running DPF REMOVED tuning, it is recommended that all sensors located in the factory exhaust system be unplugged from the electrical harnesses. These sensors can also be removed completely with the factory exhaust if desired. On the 6.6L LMM Duramax, there are usually 2 EGT Sensors and 1 Pressure Sensor.

### EGR Unplug / Delete

When running H&S DPF REMOVED tuning, it is not required to unplug or block-off the EGR system on your 6.6L LMM Duramax to disable it. The EGR system is already disabled in the tuning and will not function under any conditions. If desired, the entire EGR system can be unplugged, blocked-off, or completely removed when running H&S DPF REMOVED tuning.

#### POWER LEVELS DPF PRESENT

No Power.....	0 HP
Mild.....	40 HP
Wild.....	80 HP
Hot.....	120 HP

#### POWER LEVELS DPF REMOVED

No Power.....	0 HP
Mild.....	60 HP
Wild.....	120 HP
Hot.....	175 HP

## Speed Limiter

This option allows for the adjustment of the factory speed limiter. Most 6.6L LMM Duramax trucks have a 98 MPH speed limiter from the factory. The limiter can be adjusted from 50 MPH to 95 MPH or removed completely. This option can only be adjusted during the Install Download process.

## Tire Size Calibration

This option allows for the re-calibration of the factory speedometer to adjust for non-stock sized tires. For the most accurate speedometer reading when using non-stock sized tires, it is best to measure the diameter of the tire using a tape measure rather than going by the printed tire size. In addition, using a GPS is a great way to dial in your factory speedometer. Entering a larger tire size will cause the factory speedometer to read higher while entering a smaller tire size will cause the factory speedometer to read lower. The tire size can be adjusted from 25" to 60". This option can only be adjusted during the Install Download process.

*NOTE: On some vehicles, entering a tire size larger than 35" may cause the ABS light to illuminate.*

## Transmission Reset / Relearn

The automatic transmission on the 2007.5 - 2010 6.6L LMM Duramax has what is called **Adaptive Memory** and is constantly learning and adapting to different horsepower levels, temperatures, driving habits, etc. We highly recommend performing a Transmission Reset / Relearn procedure after installing H&S tuning to help the transmission perform correctly with the added horsepower. The transmission will eventually learn over time on its own, but the relearn procedure gives a good baseline for the adaptive learning and helps to speed up the learning process. To perform the relearn procedure, please follow these instructions:

**When re-training the transmission, ALWAYS follow posted speed limits. Do NOT attempt runs in adverse weather conditions such as snow, ice, rain, wind, or any other conditions that may affect your vehicles traction or impair your visibility!**

1. After you have installed the H&S tuning, turn the key to the **ON** position. From the Main Menu, scroll down until you see the **Reset Transmission option**. Select **Reset Transmission** and follow the on-screen instructions to reset the transmission adaptive memory.
2. After the transmission reset is complete, it is recommended to perform each of the following 0-80 MPH runs while in the **HOT** power level:
  - **0-80 MPH @ 25% throttle position, then slow down and come to a complete stop.**
  - **0-80 MPH @ 50% throttle position, then slow down and come to a complete stop.**
  - **0-80 MPH @ 100% throttle position, then slow down and come to a complete stop.**

## The Transmission Relearn procedure is complete.

**NOTE:** On any vehicle using 3" or larger lift blocks under the rear leaf pack, it is **HIGHLY RECOMMENDED** to install traction bars when adding additional horsepower.

### Keyed Ignition Source Location

Although it is possible to manually power up the Black Maxx without using a keyed ignition source, it can sometimes create communication issues between the Black Maxx and the vehicles ECM. To eliminate these problems, we highly recommend tapping into a 12V keyed ignition source to supply power to the Black Maxx only when the key is in the ON position and the vehicles ECM is online. Below you will find a commonly used 12V keyed ignition source for your vehicle:

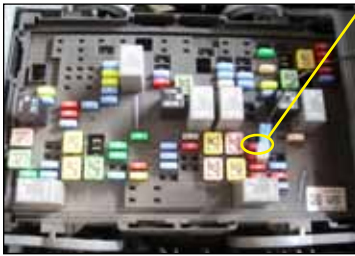

#### FUSE NUMBER 45

Always tap into the **cold** side of the fuse. On the 2007.5 - 2010 6.6L LMM Duramax, the **cold** side is towards the front of the vehicle.

**NOTE:** If your fuse box or wiring looks different than those pictured or if you are not getting 12V ignition power from the pictured source, you may need to find another 12V keyed ignition source using a test

light or multimeter. If possible, find one that stays **hot** during engine cranking.

### Pyrometer (EGT) Location

If you are installing an optional H&S pyrometer kit on your 6.6L LMM Duramax, you have the option of installing it pre-turbo or post-turbo (or both if you purchased an additional thermocouple).

For the most accurate EGT readings, we recommend installing the pyrometer pre-turbo in the passenger side exhaust manifold as seen below:



**NOTE:** The passenger side exhaust manifold can be easily accessed with the fender liner removed. Be sure to drill straight into the exhaust manifold otherwise the pyrometer probe may hit the manifold wall during installation.

For those wanting to install the pyrometer post-turbo, we usually recommend doing so in the downpipe which can also be easily accessed through the passenger side wheel well as seen below:



**NOTE:** The downpipe is pretty thin in most places, so be extra careful when tapping and installing the probe fitting. Post-turbo EGT readings can be up to 400 degrees cooler than pre-turbo EGT readings. Keep that in mind when monitoring your EGTs with a post-turbo pyrometer.

## 2011-2012 6.6L LML DURAMAX

### Power Levels

Power levels are not currently shift-on-the-fly for the 2011 - 2012 6.6L LML Duramax. To adjust the Power Level, select **Change Power Level** from the Main Menu and follow the on-screen instructions (*this may change so be sure to visit [www.hperformance.com](http://www.hperformance.com) for product updates*).

**NOTE:** The Power Level ratings listed may not be exact for your particular vehicle. The listed ratings apply to the out-of-the-box tuning that H&S tuning devices are shipped with. Any custom downloads may result in different ratings and can be found at [www.hperformance.com/black-maxx-downloads](http://www.hperformance.com/black-maxx-downloads).

### DPF Selection

The DPF or Diesel Particulate Filter is part of the factory exhaust system on the 6.6L LML Duramax. H&S offers tuning that allows the DPF to be left in place, or removed completely.

If you are planning on leaving the exhaust system stock with the DPF in place, you will select PRESENT.

### POWER LEVELS DPF PRESENT

No Power.....	0 HP
Mild.....	40 HP
Wild.....	80 HP

### POWER LEVELS DPF REMOVED

No Power.....	0 HP
Mild.....	50 HP
Wild.....	100 HP
Hot.....	150 HP

\*An additional unlock fee may apply for DPF Removed tuning.

If you have already removed the DPF or if you plan on removing the DPF immediately after installing your H&S tuning device, you will select REMOVED. If you select REMOVED, you must Accept our DPF Disclaimer in order to continue with the Install Download process.

### DPF / Exhaust Sensors

When running DPF PRESENT tuning, it is required that all sensors located in the exhaust system stay in place and plugged in, otherwise you may experience a Check Engine Light (CEL) and even a loss of power (limp mode).

When running DPF REMOVED tuning, it is required that all sensors located in the factory exhaust system be unplugged from the electrical harnesses **EXCEPT FOR THE PRESSURE SENSOR WHICH MUST REMAIN PLUGGED IN**. All sensors other than the Pressure Sensor can be removed completely with the factory exhaust if desired. On the 6.6L LML Duramax, there are usually 3 EGT Sensors, 1 NOx Sensor, 1 UREA Injector, and 1 Pressure Sensor.



The DPF Pressure Sensor is located under the bed in front of the axle on the inside of the passenger side frame rail. You may pull the two rubber lines off of the sensor but **DO NOT UNPLUG THIS SENSOR!** Unplugging of the Pressure Sensor may result in erratic engine operation and loss of power.

### UREA / SCR System

On the 2011 - 2012 6.6L LML Duramax, there is a UREA system that needs to be unplugged when running DPF REMOVED tuning. The UREA system must at least be unplugged but can be completely removed from the vehicle if desired. Failure to unplug the UREA system may result in a check engine light and/or dash messages, erratic engine operation, and loss of power. Follow these instructions to unplug the UREA system:

1. The urea injector is located between the CAT and DPF above the torsion bar crossmember. Unplug the electrical connection and the urea line.



2. The main urea harness is the large black harness located near the urea injector above the urea tank. Flip the large gray locking tab to disconnect the harness.



For complete UREA System Removal instructions, visit [www.hsperformance.com/tech](http://www.hsperformance.com/tech)

### EGR Unplug / Delete

If you are installing H&S DPF REMOVED tuning, you must unplug the EGR system on your 6.6L LML Duramax if not installing a complete EGR delete. Failing to do so may result in erratic engine operation and loss of power. Please follow these instructions carefully to unplug and disable the EGR system:

1. Unplug 3 EGR harnesses - two are brown with a yellow locking tab, one is black with a red locking tab (see pictures for locations).

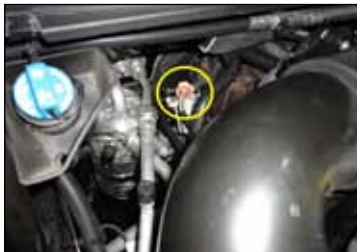

### Speed Limiter

This option allows for the removal of the factory speed limiter. Most 6.6L LML Duramax trucks have a 98 MPH speed limiter from the factory. The limiter can be removed completely

but may result in a loss of cruise control function (*this may change so be sure to visit [www.hspower.com](http://www.hspower.com) for product updates*). This option can only be changed during the Install Download process.

## Tire Size Calibration

(*Not currently available for the 2011 - 2012 6.6L LML Duramax. This may change so be sure to visit [www.hspower.com](http://www.hspower.com) for product updates*). This option allows for the re-calibration of the factory speedometer to adjust for non-stock sized tires. For the most accurate speedometer reading when using non-stock sized tires, it is best to measure the diameter of the tire using a tape measure rather than going by the printed tire size. In addition, using a GPS is a great way to dial in your factory speedometer. Entering a larger tire size will cause the factory speedometer to read higher while entering a smaller tire size will cause the factory speedometer to read lower. This option can only be adjusted during the Install Download process.

**NOTE:** *On some vehicles, entering a tire size larger than 35" may cause the ABS light to illuminate.*

## Transmission Reset / Relearn

The automatic transmission on the 2011 - 2012 6.6L LML Duramax has what is called **Adaptive Memory** and is constantly learning and adapting to different horsepower levels, temperatures, driving habits, etc. We highly recommend performing a Transmission Reset / Relearn procedure after installing H&S tuning to help the transmission perform correctly with the added horsepower. The transmission will eventually learn over time on its own, but the relearn procedure gives a good baseline for the adaptive learning and helps to speed up the learning process. To perform the relearn procedure, please follow these instructions:

**When re-training the transmission, ALWAYS follow posted speed limits. Do NOT attempt runs in adverse weather conditions such as snow, ice, rain, wind, or any other conditions that may affect your vehicles traction or impair your visibility!**

1. After you have installed the H&S tuning, turn the key to the ON position. From the Main Menu, scroll down until you see the **Reset Transmission** option. Select **Reset Transmission** and follow the on-screen instructions to reset the transmission adaptive memory.
2. After the transmission reset is complete, it is recommended to perform each of the following 0-80 MPH runs while in the **HOT** power level:
  - **0-80 MPH @ 25% throttle position, then slow down and come to a complete stop.**
  - **0-80 MPH @ 50% throttle position, then slow down and come to a complete stop.**
  - **0-80 MPH @ 100% throttle position, then slow down and come to a complete stop.**

## The Transmission Relearn procedure is complete.

**NOTE:** On any vehicle using 3" or larger lift blocks under the rear leaf pack, it is **HIGHLY RECOMMENDED** to install traction bars when adding additional horsepower.

### Keyed Ignition Source Location

Although it is possible to manually power up the Black Maxx without using a keyed ignition source, it can sometimes create communication issues between the Black Maxx and the vehicle's ECM. To eliminate these problems, we highly recommend tapping into a 12V keyed ignition source to supply power to the Black Maxx only when the key is in the ON position and the vehicle's ECM is online. Below you will find a commonly used 12V keyed ignition source for your vehicle:

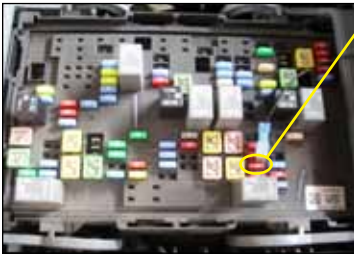

#### FUSE NUMBER 45

Always tap into the **cold** side of the fuse. On the 2011 - 2012 6.6L LML Duramax, the **cold** side is towards the front of the vehicle.

**NOTE:** If your fuse box or wiring looks different than those pictured or if you are not getting 12V ignition power from the pictured source, you may need to find another 12V keyed ignition source using a test

light or multimeter. If possible, find one that stays **hot** during engine cranking.

### Pyrometer (EGT) Location

If you are installing an optional H&S pyrometer kit on your 6.6L LML Duramax, you have the option of installing it pre-turbo or post-turbo (or both if you purchased an additional thermocouple).

For the most accurate EGT readings, we recommend installing the pyrometer pre-turbo in the passenger side exhaust manifold as seen below:



**NOTE:** The passenger side exhaust manifold can be easily accessed with the fender liner removed. Be sure to drill straight into the exhaust manifold otherwise the pyrometer probe may hit the manifold wall during installation.

For those wanting to install the pyrometer post-turbo, we usually recommend doing so in the downpipe which can also be easily accessed through the passenger side wheel well as seen below:



**NOTE:** The downpipe is pretty thin in most places, so be extra careful when tapping and installing the probe fitting. Post-turbo EGT readings can be up to 400 degrees cooler than pre-turbo EGT readings. Keep that in mind when monitoring your EGTs with a post-turbo pyrometer.

## SECTION 8: UNPLUGGING THE HEAD UNIT

### 2003 - 2007 5.9L Dodge Cummins

If you unplug your head unit your truck will remain at the last known power level you had it set to.

### 2007.5 - 2009 6.7L Dodge Cummins

If you unplug your head unit, your truck will default to the NO POWER setting within a few drive cycles.

### 2010 - 2011 6.7L Dodge Cummins

If you unplug your head unit, your truck will default to the NO POWER setting within a few drive cycles.

### 2003 - 2007 6.0L Ford Powerstroke

If you unplug your head unit your truck will remain at the last known power level you had it set to.

### 2008 - 2010 6.4L Ford Powerstroke

If you unplug your head unit your truck will remain at the last known power level you had it set to.

### 2011 - 2012 6.7L Ford Powerstroke

If you unplug your head unit, your truck will default to the NO POWER setting within a few drive cycles.

### 2007.5 - 2010 Duramax LMM

If you unplug your head unit your truck will remain at the last known power level you had it set to.

### 2011 - 2012 Duramax LML

Not shift-on-the-fly so unplugging head unit will not affect power level setting.



Like

## **"LIKE" Us on facebook!**

For chances to win free products from H&S Performance.

We do monthly contests for items like:

**T-Shirts, TUNERS and More!**



**LEADING THE INDUSTRY IN  
LATE MODEL DIESEL TUNING**

**[facebook.com/hperformance](https://facebook.com/hperformance)**

# BRING ON THE POWER



**H & S Performance, LLC**

**4160 South River Road  
St. George, UT 84790  
435-628-1730**

**WWW.HSPERFORMANCE.COM**